

**NINZ**®  
FIREDOORS

## REVER multipurpose doors

**"bare minimum, maximum performance!"**



# Features

## REVER multipurpose doors

### THE ECONOMICAL MULTIPURPOSE YOU ALWAYS WISHED FOR

#### “Quality first”

- Fully galvanized, including the “hidden” parts
- Made of “Sendzimir” processed hot-galvanized sheet metal
- Corrosion protection also provided along the cut edges of the metal
- Painted with epoxy-polyester thermoset powders in a 180 degree (Celsius) oven
- Extra-thick paint layer (over 70 microns)
- Optimal corrosion resistance as demonstrated by 500 hour salt-fog testing
- Finishing with high-quality aesthetics
- Orange skin anti-scratch structured paint
- Customizable with wide selection of RAL colors

#### “Practicality of use”

- Door reversibility\*
- Indication of door opening direction not necessary
- Reduction of stock for retailers
- Simplifies choices for end customers
- Especially well-suited for indoor use
- Light but still sturdy
- Easy installation

#### “Versatility”

- Very wide field of application
- Can be combined with various frame types
- Installable onto any wall type
- Application with a block frame
- Can be combined with over-head frame panel with or without ventilating perforation
- Available with upper/lower crack enlargement
- Vast assortment of accessories
- Customized measurements also available

#### “Manufacturing technology”

- Manufacturing in modern and functional facilities which employ the latest technologies to maintain high quality levels and product uniformity
- The entire production process - from raw materials to painted and packaged products - takes place inside Ninz’s own facilities, ensuring a 360 degree door control



One-leaved doors



Two-leaved doors

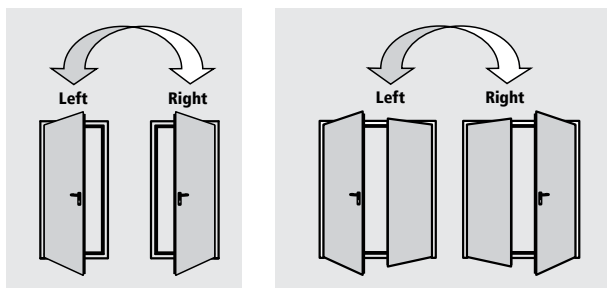

\*except in combination with certain optional accessories

## STANDARD ELEMENTS

which comprise Rever multipurpose doors:

### Door

- Made of "Sendzimir" processed hot-galvanized sheet metal, press folded
- Perimetral rebate on 4 sides
- Internal corrugated honeycomb fiber structure fixed firmly to the sheet metal
- Thickness of 40 mm

### Doorframe

- Made of "Sendzimir" processed hot-galvanized sheet metal
- Grooves for rebate sealing
- Suitable for anchors for mortar fixing or expansion screws
- Detachable rebate for application on finished flooring
- Removable threshold for thresholdless installation
- Strike plates in black plastic for lock bolt
- Assembled doorframes for one-leaved doors
- Assembly required for two-leaved doorframes

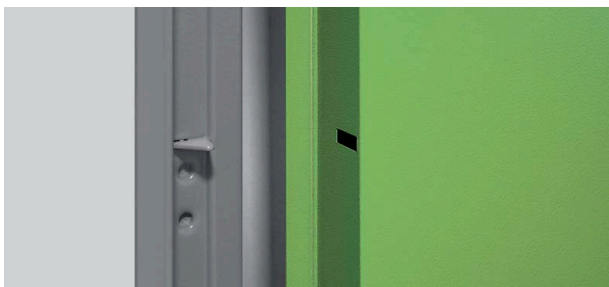
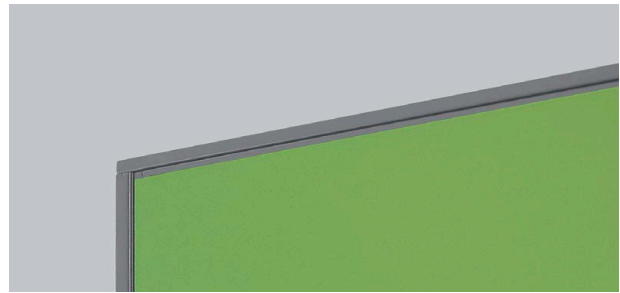

### Hinges

- Nr. 2 three-wing hinges for each leaf

### Locking mechanism

- Reversible locking mechanism with bolt and central latch
- Insert with patent key, Euro profile cylinder ready

### Handle

- Black plastic handle
- Fastener screws to pass
- Insert for patent-type key

### Safety bolts

- Nr. 3 safety bolts applied on hinge side doorframe edge

# Features

## REVER multipurpose doors



### INCLUDED ACCESSORIES

which comprise Rever multipurpose doors:

#### Safety lock

- Central latch for blocking and unblocking the inactive leaf
- Lever control for unlocking vertical rods

#### Upper coupling system for the inactive leaf

- Vertical rod with steel point which inserts into the upper strike box
- Upper strike box in black plastic with steel roller

#### Lower coupling system for the inactive leaf

- Vertical rod with steel point which inserts into lower strike box
- Floor catch (floor-mounted bushing) in black plastic, for doors without threshold
- Floor catch in black plastic with a steel roller, for doors with threshold

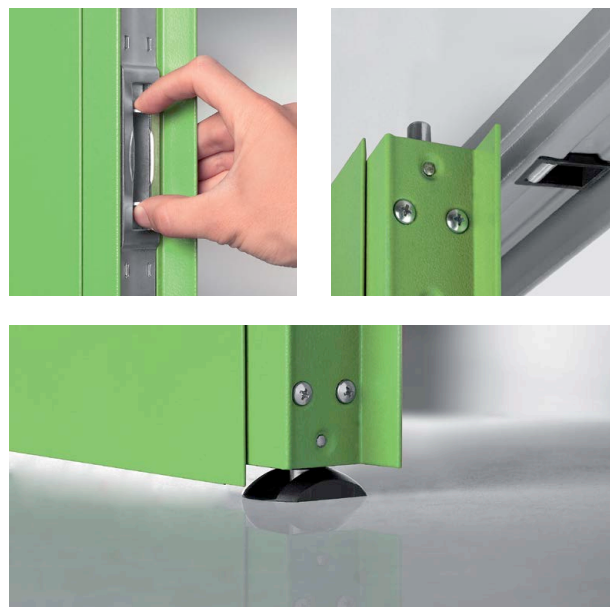

#### Standard paint - group 01:

leaf color NCS 4020-B50G

frame color NCS 5020-B50G



#### Finishing

- Standard painted with epoxy-polyester thermoset powders in a 180 degrees oven, orange skin, anti-scratch finishing
- Standard pastel turquoise color, lighter tone for the leaf (NCS4020-B50G), darker tone for the frame (NCS5020-B50G)

#### Standard packaging

- Single door wrapped into stretchable polyethylene (PE) film
- Assembled doorframes for one-leaved doors
- Assembly required for doorframes for two-leaved doors
- Palletized on wooden pallets

#### Pre-settings

- Each door is ready for the installation of a three-point SECUR lock
- The main lock and upper rod housing on the inactive leaf are ready for installation of the latching mechanism for panic bars

#### Door weight kg/m<sup>2</sup> of wall opening

1 leaf	15
2 leaves	14

#### NOTE

If the door ever needs to be repainted, follow the precise instructions on the "Painting" page.

# Features

## REVER multipurpose doors

### OPTIONAL ACCESSORIES

A wide variety of accessories and surface finishes are available on request for maximum value enhancement of Rever doors to your own specific needs.

The proper accessories can help resolve:

#### Safety-related needs

- Doors for panic exits (see panic bars)
- Doors for emergency exits (see emergency exit handles)
- Three-point Rever SECUR lock

#### Installation and utilization needs

- Embracing or telescopic frames
- Frame extensions
- Drip steel-profile
- Kick and protection plates in stainless steel
- Windows
- Ventilating perforation
- Overhead frame panel
- Available with upper/lower crack enlargement

#### Access-related control issues

- Electrically-activated lock mechanisms
- Electric handle mechanisms
- Magnetic blocking mechanisms

#### Performance enhancing

- Rebate sealings
- Cylinders
- Door closers
- Special handles



#### NOTE

Details about optional accessories may be found in the following chapters of this brochure:

- Painting and NDD decorations
- Accessories for metal doors
- Emergency handles and panic bars

Right-opening doors are the default selection if opening direction is not specified.

#### Customized finishing

- Select finishing from a wide variety of RAL colours
- NDD – Ninz Digital Decor, graphic images applied with special ink jets and protected by a transparent topcoat. Infinite varieties of customizable decorations in harmony with specific door settings
- Stainless steel handles
- Colored handles

#### Packaging for maximum protection

Sturdy wooden crates protect all doors and related accessories

- For NDD decorated doors
- On construction sites
- During shipping abroad
- For special transport

The following optional accessories make Rever doors irreversible, requiring the indication of the door opening direction when the order is placed:

- SLASH panic bar
- Panic bar for inactive leaves
- Windows and ventilation grills
- MAC locks
- ELM/cisa and ELM/mt electric handle
- Special locks (016 tir- Stel 15)
- Overhead frame panels and prolonged frames
- Special doorframes (SPEED, SOLID, TESCOP)

# Specific optional accessories

## REVER multipurpose doors

### MULTIPURPOSE WINDOW

On request, the one- and two-leaved doors may be equipped with round or rectangular windows, with stratified 3 + 3 mm glass, 2B2 rated, framed with a black rubber EPDM profile. The corners of rectangular windows are rounded (radius of approx. 100 mm).

#### Production limits

Window sizes are standard and the minimum border strips around the window may not be reduced.

#### Borders, window position

"Border measurement" refers to the distance from the edge of the window to the wall opening of the door.

#### Elevation for round windows

window size	FM H	position
Ø 300	minimum 1950	Y=1600
Ø 300	less than 1950	Y=FM H - 350
Ø 400	minimum 2000	Y=1600
Ø 400	less than 2000	Y=FM H - 400

#### Elevation for rectangular windows

window dimensions L x H	FM H	position
300 x 500	minimum 1950	Z=1500
300 x 500	less than 1950	Z=FM H - 450
400 x 700	minimum 2050	Z=1500
400 x 700	less than 2050	Z=FM H - 550

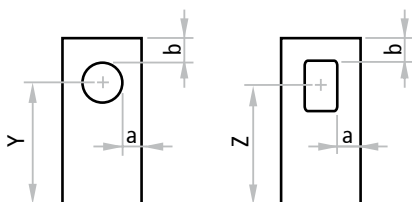

#### KIT window

The windows for Rever doors are also available as a KIT for later installation directly by the customer.

#### NOTE

The positions indicated above are those standard. Different positions may be considered as long as they respect the minimum "a" and "b" border strips.



#### Round and rectangular window cross sections

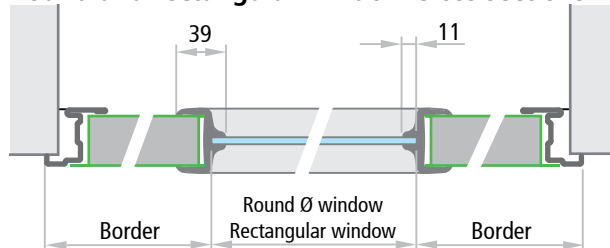

#### Window dimensions

		minimum border		FM L min. dimensions
		a	b	
	Ø 300	200	200	700
	Ø 400	200	200	800
	Ø 300	200	200	L1 700 + L2 400
	Ø 400	200	200	L1 800 + L2 400
	Ø 300	200	200	L1 700 + L2 700
	Ø 400	200	200	L1 800 + L2 800
	300 x 500	200	200	700
	400 x 700	200	200	800
	300 x 500	200	200	L1 700 + L2 400
	400 x 700	200	200	L1 800 + L2 400
	300 x 500	200	200	L1 700 + L2 700
	400 x 700	200	200	L1 800 + L2 800

# Specific optional accessories

## REVER multipurpose doors



REVER multipurpose

### SPECIAL ‚SPEED‘ DOORFRAME FOR REVER DOORS

SPEED on three sides embracing doorframe with 45 deg. joints, made of 1,25 mm thick galvanized „Sendzimir“ processed sheet metal, assembly required. For installation onto finished walls using 6 integrated clamps and two adjustable spacers with plugs or screws. Includes rebate sealing and RAL painting with thermoset epoxy-polyester powders. Minimum 75mm wall thickness, 55/70 frames.

Order measurements	required wall opening	doorframe opening
FM L (width)	FM L + 20	FM L - 64
FM H (height)	FM H + 10	FM H - 34

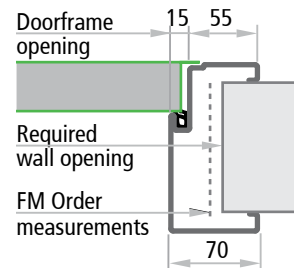

### SPECIAL ‚SOLID‘ DOORFRAME FOR REVER DOORS

SOLID on three sides embracing doorframe with 45 deg. joints, made of 1,25 mm thick galvanized „Sendzimir“ processed sheet metal, assembly required. For installation with anchors for mortar fixing or with fastening profiles to fix with plugs or screw on, including removable threshold spacer, sealing and RAL painting with thermoset epoxy-polyester powders. Minimum 50mm wall thickness, 45/45 frames.

Order measurements	required wall opening	doorframe opening
FM L (width)	FM L + 40	FM L - 64
FM H (height)	FM H + 20	FM H - 34

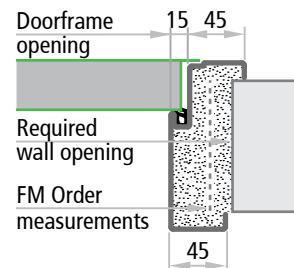

### SPECIAL ‚TESCOP‘ DOORFRAME FOR REVER DOORS

Two-pieced TESCOP on three sides embracing doorframe with 45 deg. joints, made of 1,25 mm thick galvanized „Sendzimir“ processed sheet metal, assembly required. To be fixed to finished wall with screws, including removable threshold spacer, sealing and RAL painting with thermoset epoxy-polyester powders. Minimum 70mm wall thickness, adjustment range of +25mm, frames 55/70.

Order measurements	required wall opening	doorframe opening
FM L (width)	FM L + 20	FM L - 64
FM H (height)	FM H + 10	FM H - 34

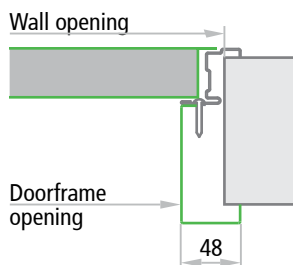
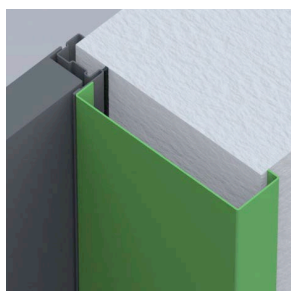
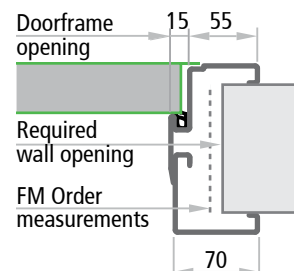

### IM21 FRAME EXTENSION FOR REVER DOORS

Frame extension to be screwed to the Rever doorframe acting as a wall cladding. Made of „Sendzimir“ processed hot-galvanized sheet metal painted the same color as the doorframe with epoxy-polyester powders. Profile on three sides, upper corners with 45 degree joint. To mount the frame extension, fixing holes need to be drilled into doorframe on site. Combine with sealing to conceal the screw heads.

Minimum 60mm wall thickness.

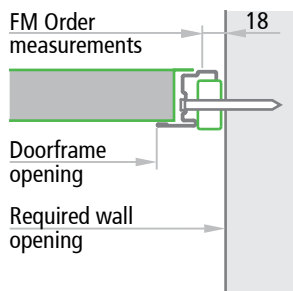
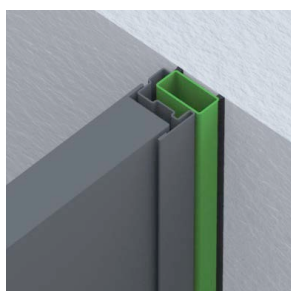

### INSTALLATION „IN THE REVEAL“ WITH BLOCK FRAME

On request additional block profiles for one- and two-leaved multipurpose Rever doors. Consists of 3 sections of hollow 40x20x1,5mm metal profiles painted the same color as the doorframe using thermoset epoxy-polyester powders. Installation with screws and plugs (screws and plugs not included).

Required wall opening = FM L + 36, FM H + 18

# Specific optional accessories

REVER multipurpose doors



REVER  
multipurpose

## VENTILATION LOUVER

Ventilation louver made of either black or white PVC, 482x99mm (air passage approx. 150cm<sup>2</sup>). The opening direction of the door needs to be specified.

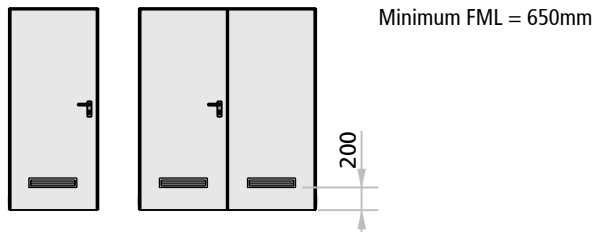

## VENTILATING PERFORATIONS

Ventilating perforation for one- and two-leaved Rever doors and for the active leaf of two-leaved doors; made by perforating the illustrated pattern into the sheet metal. Rever doors with ventilating perforations remain reversible.

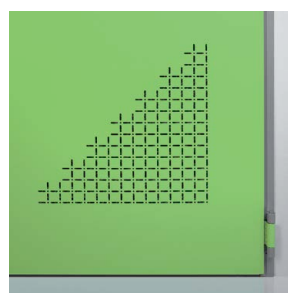
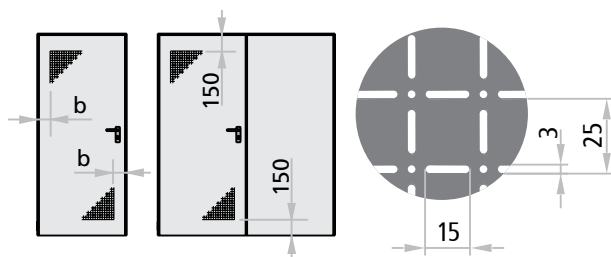

**NOTE**  
Ventilating perforations are only provided on the active leaf of two-leaved doors.

FM L / FM L1	perforation	aeration	borders (b)
< 560 mm	not possible	-	-
from 560 to 700 mm	300 x 300 mm	156 cm <sup>2</sup>	100 mm
from 701 to 1000 mm	350 x 350 mm	208 cm <sup>2</sup>	100 mm
> 1000 mm	350 x 350 mm	208 cm <sup>2</sup>	150 mm

## OVERHEAD FRAME PANEL

A prolonged frame with a galvanized, eventually perforated 12/10 mm thick piece of sheet metal to serve as the overhead frame panel with ventilating perforation, which also functions as the upper rebate for the leaf. Painted the same color as the leaf using thermoset epoxy-polyester powders. Also available for Speed, Solid and Tescop door-frames. Overhead panel delivered not mounted.

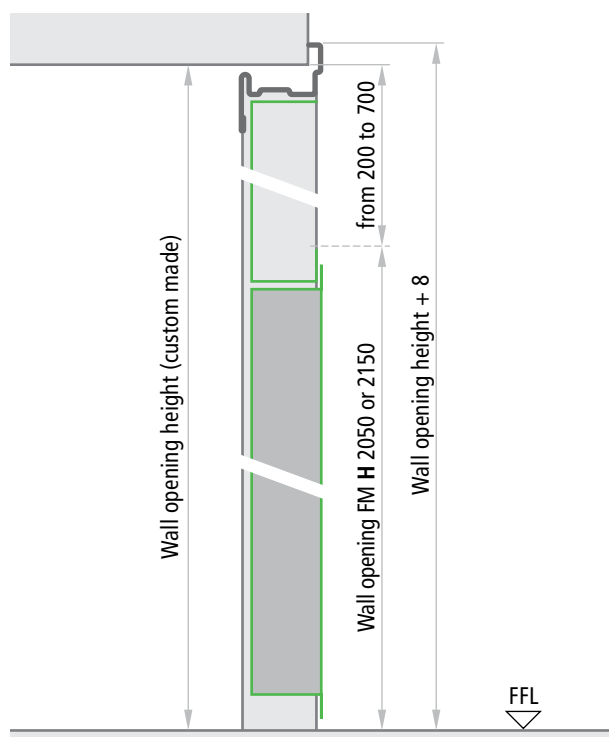
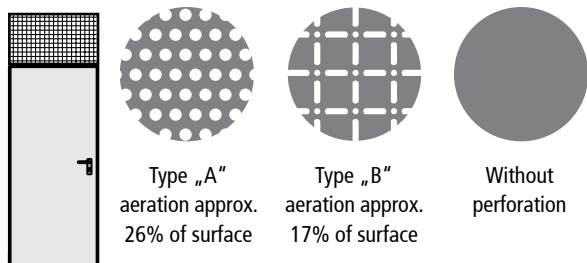

**NOTE**  
The direction of panel's installation can be chosen by the customer.



# Specific optional accessories

## REVER multipurpose doors



REVER multipurpose

### DOOR WITH EXTENDED FRAME

Frame extends beyond the door leaf to create a gap of height (h) varying of between 50 to 150 mm, either below or both above and below. When using the standard Rever door leaf and an extended frame, the positioning of the handle is higher as a consequence.

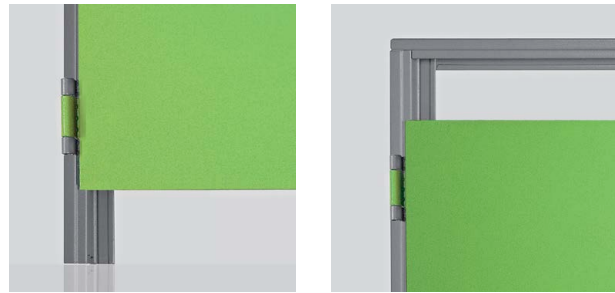
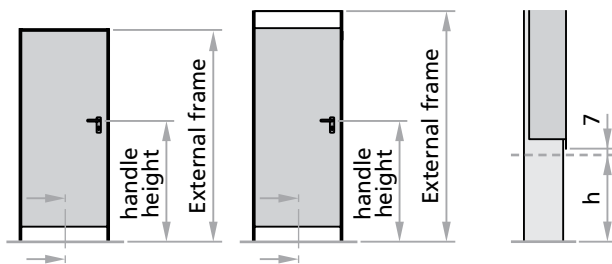

	Handle height	external frame	required wall opening
crack below	$FM H / 2 + 50 + h$	$FM H + h + 8$	$FM H + h$
crack below and above	$FM H / 2 + 50 + h$	$FM H + 2 x h + 8$	$FM H + 2 x h$

#### NOTE

The extended frame is also available as SPEED, SOLID or TESCOP version.

### THREE-POINT SECUR LOCK FOR REVER DOOR

The SECUR version of Rever provides a more reliable door closure. Activating the lock with a key blocks the leaf in the frame at three points: in the center with the latch bolt, above with the rod that inserts into the upper strike box and below with the rod that inserts into the lower strike box.

Also available as a KIT for on-site installation. SECUR Rever doors remain reversible.



upper strike box

lower strike box (bushing)

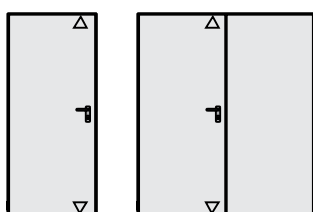

▷ Additional locking points

#### NOTE

Not available in the following versions: anti-panic, with overhead panel or with extended frame. In case of SECUR version, the standard cylinder is supplied.

### FF REBATE SEALING

FF sealing in black extruded profile to cut and to be pressed into the dedicated groove of the perimetral frame. FF sealing in black extruded profile self-adhesive to cut for application to the central joint of two-leaved doors.

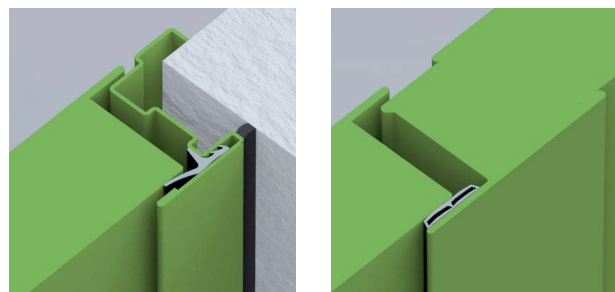

perimetral frame

central joint for two-leaved doors

# Door cross sections - Measurements

REVER multipurpose doors



## One-leaved doors

Horizontal cross section

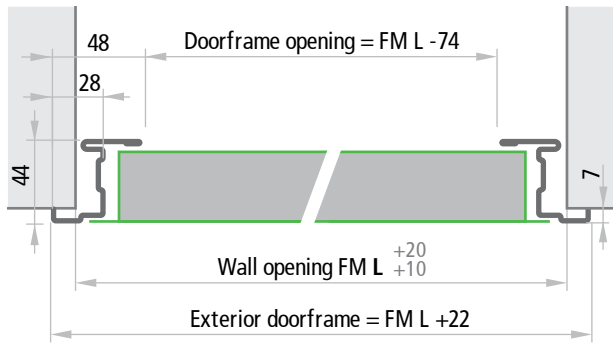

## Doors without lower threshold

Vertical cross section

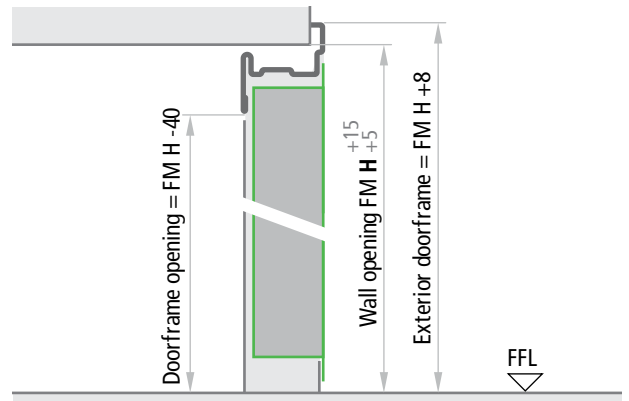

## Doors with internal and external lower threshold

Vertical cross section

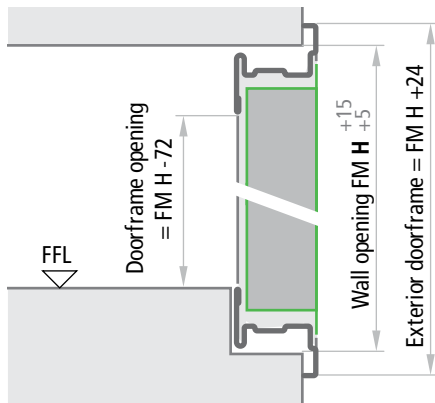

## Doors with internal lower threshold

Vertical cross section

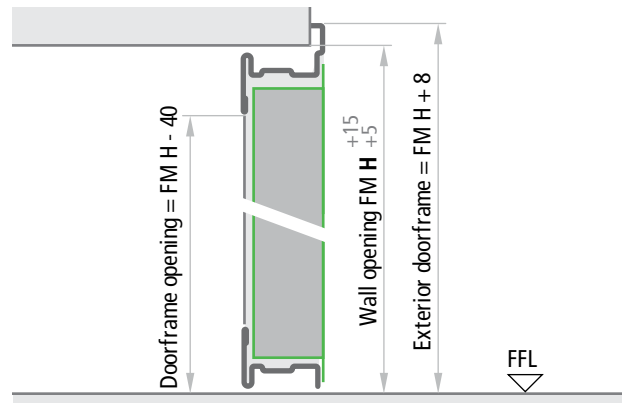

## Two-leaved doors

Horizontal cross section

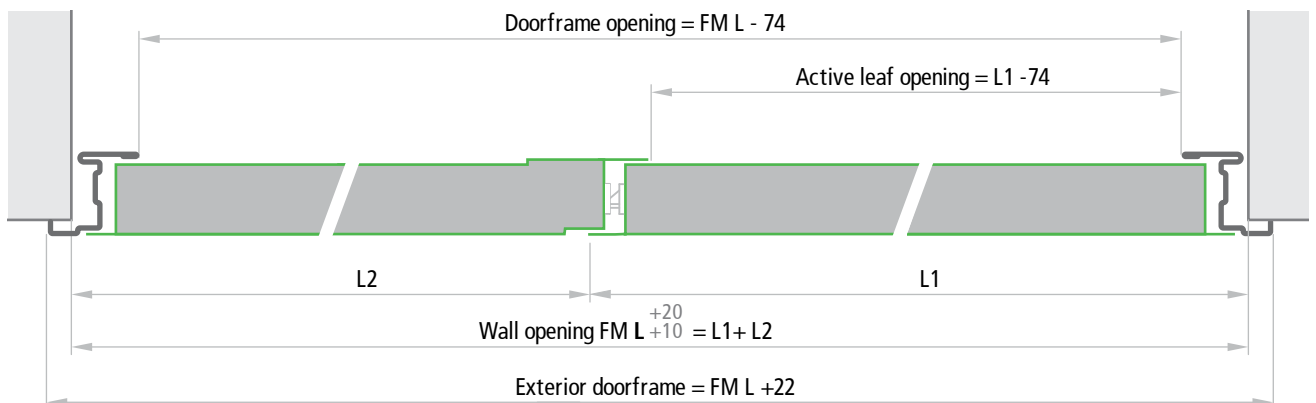

### Leaf thickness

MULTIPURPOSE	40 mm
--------------	-------

### NOTE

The tolerances  $FM L +20$ ,  $FM H +15$  of the indicated measurements make it easier to fill the gap between the wall and the doorframe with cement mortar. For dry wall installation, the holes must be precise and greater tolerance ranges should not be employed.

## INSTALLATION WITH ANCHORS FOR MORTAR FIXING

For mortar fixing, appropriate cuts will need to be created in the walls (section 80 x 160 mm) or the anchors should be fixed with expansion screws. The anchors should be bent and blocked inside the wall. For a perfect mechanical fit, the space between the doorframe and the masonry shall always be filled with concrete mortar or polyurethane foam.



## INSTALLATION FOR EXPANSION SCREWS FIXING

For the installation with expansion screws, the anchors serve as spacers and should not be bent. Using Würth type art. 0910436112 plugs or similar (supplied at the customer's expense), installation is done with expansion screws into the pre-drilled holes present on the frame. For a perfect mechanical fit, the space between the doorframe and the masonry shall always be filled with concrete mortar or polyurethane foam.

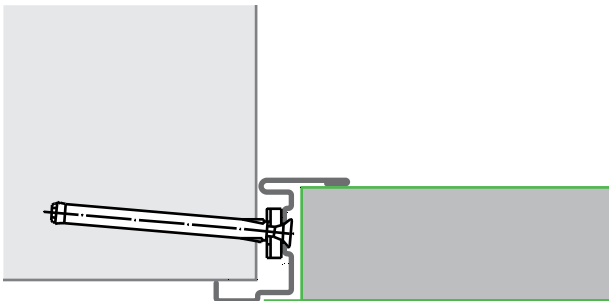

## ANCHOR POSITIONING

### One-leaved doors

Right opening and Left opening

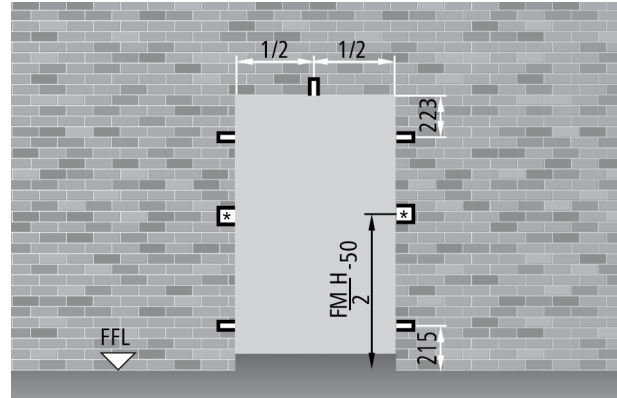

### Two-leaved doors

Right opening

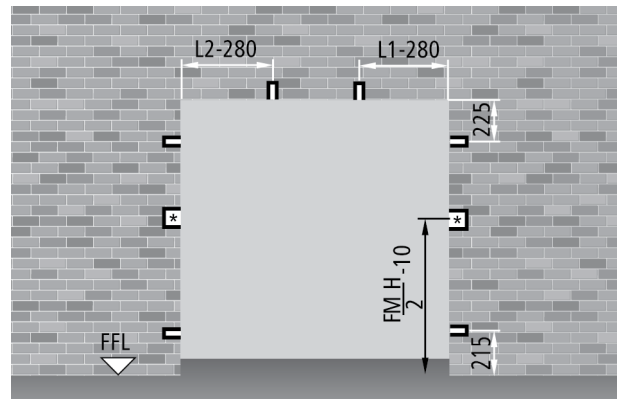

Left opening

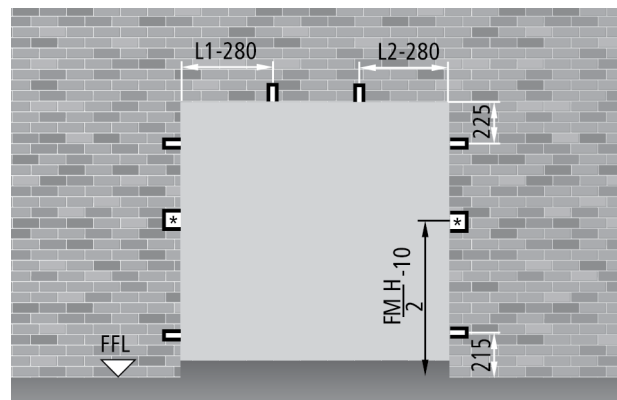

(\*) For proper installation, the cuts for the anchors should be 200 x 160 mm in size.

# Order measurements

## REVER multipurpose doors

### ORDER MEASUREMENTS

#### Wall Opening

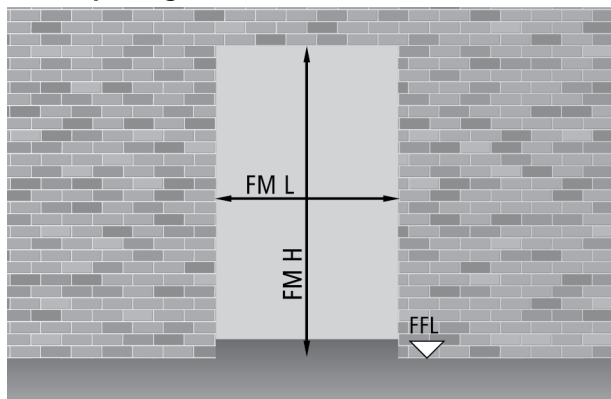

#### Doorframe opening

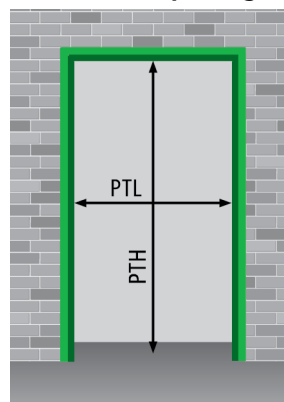

#### One-leaved doors

$$PTL = FML - 74$$

$$PTH = FMH - 40$$

#### Two-leaved doors

$$PTL = FML - 74$$

$$PTH = FMH - 40$$

#### One-leaved door FM L x FM H

##### standard dimensions

700	x	2050 / 2100 / 2150 / 2200*
800	x	2050 / 2100 / 2150 / 2200*
900	x	2050 / 2100 / 2150 / 2200*
1000	x	2050 / 2100 / 2150 / 2200*
1100	x	2050 / 2100* / 2150 / 2200*
1200	x	2050 / 2100* / 2150 / 2200*
1300	x	2050 / 2100* / 2150 / 2200*
1350	x	2050 / 2100* / 2150 / 2200*

#### PT L x PT H

##### doorframe opening

626	x	2010 / 2060 / 2110 / 2160
726	x	2010 / 2060 / 2110 / 2160
826	x	2010 / 2060 / 2110 / 2160
926	x	2010 / 2060 / 2110 / 2160
1026	x	2010 / 2060 / 2110 / 2160
1126	x	2010 / 2060 / 2110 / 2160
1226	x	2010 / 2060 / 2110 / 2160
1276	x	2010 / 2060 / 2110 / 2160

##### semi-standard dimensions

from 500 to 1345 x 2050 / 2150

from 526 to 1271 x 2010 / 2110

##### non-standard dimensions

from 500 to 1350 x from 1780 to 2150

from 526 to 1276 x from 1740 to 2110

#### Two-leaved doors FM L (L1+L2) x FM H

##### standard dimensions

1200	( 800 + 400)	x 2050 / 2100* / 2150 / 2200*
1300	( 900 + 400)	x 2050 / 2100* / 2150 / 2200*
1400	( 700 + 700)	x 2050 / 2100 / 2150 / 2200*
1600	( 800 + 800)	x 2050 / 2100 / 2150 / 2200*
1800	( 900 + 900)	x 2050 / 2100 / 2150 / 2200*
2000	(1000 + 1000)	x 2050 / 2100 / 2150 / 2200*

#### PT L x PT H

##### doorframe opening

1126	x	2010 / 2060 / 2110 / 2160
1226	x	2010 / 2060 / 2110 / 2160
1326	x	2010 / 2060 / 2110 / 2160
1526	x	2010 / 2060 / 2110 / 2160
1726	x	2010 / 2060 / 2110 / 2160
1926	x	2010 / 2060 / 2110 / 2160

##### semi-standard dimensions

from 900 (500+400) to 2000 (1000 + 1000) x 2050 / 2150

from 826 to 1926 x 2010 / 2110

##### non-standard dimensions

from 900 (500+400) to 2000 (1000 + 1000) x from 1780 to 2150

from 826 to 1926 x 1740 / 2110

\* limited dimensions available - see the price list

#### NOTE

Unless specified otherwise by the customer, two-leaved standard, semi-standard and customized doors are supplied with a right-pull opening direction.

# Opening measurements - Overall dimensions

REVER multipurpose doors



REVER multipurpose

## OPENING MEASUREMENTS AND OVERALL DIMENSIONS WITH 90 DEGREE OPENING

### One-leaved doors with panic bar

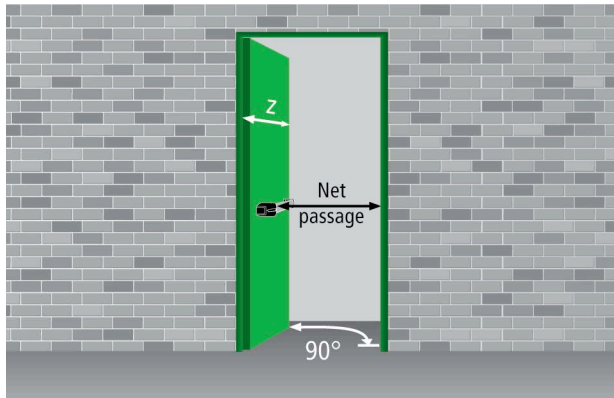

### Two-leaved doors with panic bars

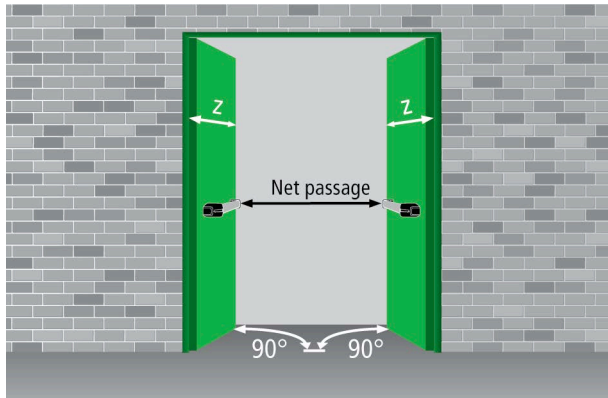

### Net passage calculation

panic bar type	protrusion	one-leaved door	two-leaved door
EXUS	125	FML - 209	FML - 344
TWIST	100	FML - 184	FML - 294
SLASH	75	FML - 159	FML - 244
FAST TOUCH	75	FML - 159	FML - 244
without panic bar	-	FML - 84	FML - 94
z = leaf protrusion relative to the wall		FML + 11	L1 + 11 L2 + 56

## OVERALL DIMENSIONS WITH 180 DEGREE OPENING - HANDLE HEIGHT

### One-leaved door

$$x = FML - 4$$

$$h \text{ handle} = FMH/2 + 50$$

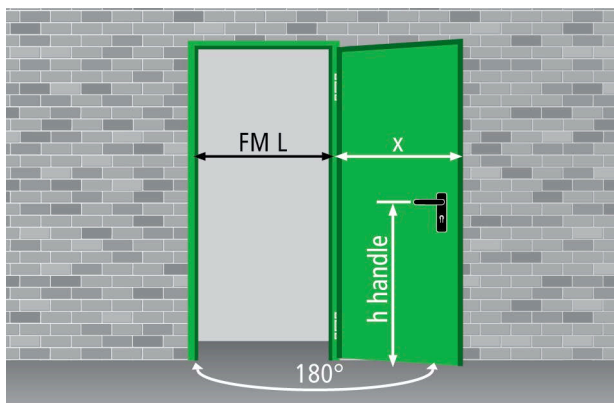

### Two-leaved door

$$x = L1 - 4 \quad y = L2 + 42$$

$$h \text{ handle} = FMH/2 + 50$$

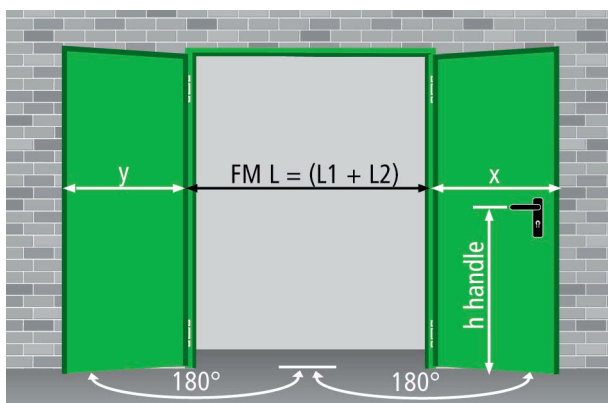

## Painting

This standard door is painted with thermoset powders, anti-scratch orange skin and semi-glossy finish (except for certain colors). The paint is particularly resistant and offers a pleasant finish for interior applications. Choose from a wide range of RAL colors.







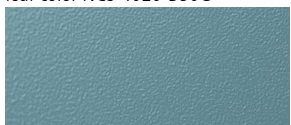

### COLORS FOR INTERIOR USE WITHOUT PRICE SUPPLEMENT

Paint for interior use (group 01) with epoxy-polyester powders.

Standard colors (without any specification): turquoise pastel - lighter tone for the leaf (NCS4020-B50G) and darker for the frame (NCS5020-B50G).

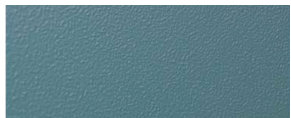









Other RAL colors are available upon request (to be indicated in the order).























Group 01 - standard colors:	RAL colors upon request:			
leaf color NCS 4020-B50G	RAL 1013	RAL 5010	RAL 7016	RAL 7035
				
frame color NCS 5020-B50G	RAL 9010			
				

### COLORS FOR INTERIOR USE WITH PRICE SUPPLEMENT

Paint for interior use (groups 02 and 03) available in a variety of RAL colors with epoxy-polyester powders. Doors must be protected from atmospheric agents. Sunlight fades the colors.

Distinct from other RAL colours, metallic tinted paints RAL 9006, RAL 9007 (group 3) and RAL 9006 E (group 04) present a finish with a wrinkled structure that requires pre-approval of a sample.

Group 02:							
RAL 1015	RAL 5024	RAL 6000	RAL 7024	RAL 7038	RAL 8011	RAL 9001	RAL 9002
							
RAL 9011	RAL 9016	RAL 9018					
							

Group 03:							
RAL 1001	RAL 1003	RAL 3000	RAL 3003	RAL 3020	RAL 5012	RAL 5015	RAL 6005
							
RAL 7001	RAL 7004	RAL 7011	RAL 7030	RAL 7032	RAL 7037	RAL 7040	RAL 7042
							
RAL 7047	RAL 8017	RAL 8019	RAL 9005	RAL 9006*	RAL 9007*		
							

\*requires pre-approval of a sample.

## COLORS FOR EXTERIOR USE WITH PRICE SUPPLEMENTS

Paint for exterior use (group 04) with polyester powders in various RAL colours.

Group 04:							
RAL	RAL	RAL	RAL	RAL	RAL	RAL	RAL
1013E	3000E	5010E	6005E	7016E	7024E	7035E	9002E
RAL	RAL	NCS	NCS				
9006E*	9010E	4020E	5020E				

\*requires pre-approval of a sample.

## COLORS ON REQUEST WITH PRICE SUPPLEMENTS

Paint available for interior and exterior use (group 05) with epoxy-polyester and polyester (respectively) powders in the requested RAL colours. Group 05 does not include special colors, such as metallic, mica, smooth or wrinkled texture and other sample colours like Pantone, NCS, etc.

Group 05:
Colors on request only

## SPECIAL PAINTING ON REQUEST WITH PRICE SUPPLEMENTS

### Bacterial proof painting

Paint available for interior and exterior (group 06) with epoxy-polyester and polyester with silver ions additives. On surface painted with this particular treatment, germs are hindered to take root and proliferate, offering good resistance to routine cleaning. Particularly suitable for use on doors intended for health care facilities, food industries, schools and child care, etc.

### Graffiti proof painting

Paint for exterior (group 06) that allows, through a special solvent, to easily remove the graffiti. It provides long-lasting protection, allowing repeated cleanings without damaging the finish.

Group 06:
Colors on request only

## PRECAUTIONS

### Installation

In case of exterior installation of the doors, in addition to use special paints which are especially designed for this kind of application (see groups 04 and 05), in order to avoid any product degradation, it is important to:

- protect the doors from bad weather and water seeping in;
- avoid direct sun rays and the subsequent warping of the door leaf, especially in case of darker colors.

For more details, refer to the "Notices" section of this brochure.

### Cleaning

Water and neutral soap are recommended for the regular cleaning of our products. Do not use common cleaning products (see detergents) and/or other solvents. We shall not be held responsible for any problems that arise if these guidelines are not respected.

### Re-painting

- For re-painting, use the following procedure:
- sand and carefully wipe away any dust from the surfaces
- apply a base coat of semi-gloss acrylic (we recommend the product ACRILFIN SL series 567 made by ELCROM - Italy + 20% by weight aliphatic hardener series E872003)
- repaint the surfaces with your choice of lacquers or paints.

### Retouching

Upon request, the company Ninz also provides touch-up colors for the required RAL colour paint (nitro/synthetic) in 60 gr. handy bottle with brush cap or in 1,00 kg can.



**Ninz Digital Decor**  
NDD provides clients with an infinite number of graphic possibilities applicable to the surfaces of NINZ doors.

## DESCRIPTION

NDD - Ninz Digital Decor decorative painting. Graphic illustrations are applied directly to the flat surfaces of the door leaf after it has been painted with a base coat of polymerized powders. Painting with high-resolution digital print using special ink jets. The application of an additional layer of transparent coating ensures optimal protection of the decorative paint. Decorative NDD painting is available for the entire range of one- and two-leaved Rever, Univer and Proget doors.

**NDD® - Ninz Digital Decor introduces style and design to metal door products. Ninz doors can be directly printed with either your company's logo or designs, materials and symbols selected from a wide variety of NDD®, or also with your preferred artwork or customized images. NDD® introduces innovations to doors as an architectural entity; introducing NDD® can create added value on socio-cultural, economic and emotional dimensions.**

awarded with the  
**security&safety**  
award

**The [www.ninz.it](http://www.ninz.it) website illustrates an infinity of continuously updated decorations that have been categorized into eight groups for rapid review. The groups are listed on the next page.**

Laboratory testing executed on NDD® samples	result
500 h exposure test in salt fog	good performance, no sign of deterioration encountered
500 h humidity resistance test	good performance, no deterioration or loss of surface shine
500 h UVA radiation resistance test	good performance, no deterioration or loss of surface shine
Abrasion resistance test after 1000 cycles	the decoration was unaltered
Solvent resistance test	good performance, no deterioration in the decoration or the background paint



**ARTLINE** This group includes a wide selection of famous artworks drawn from ancient history up to the present day. These extraordinary designs endow the environment with a special atmosphere as an expression of style.

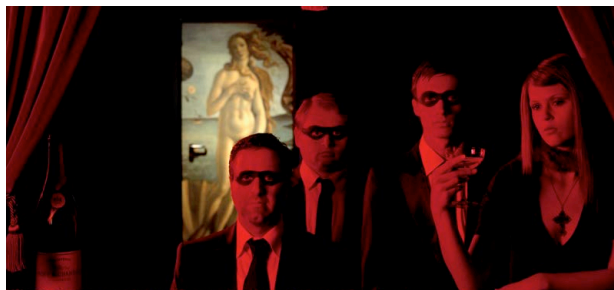

**WOOD** This set includes an endless variety of realistic imitations of classic, exotic, special and colored types of wood.

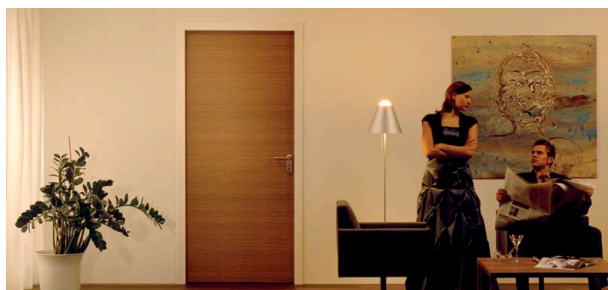

**FANTASY** NDD is a data bank of exclusive NINZ images and creations.



**STONES** This selection includes an endless variety of realistic imitations of marbles, granites and other stones.

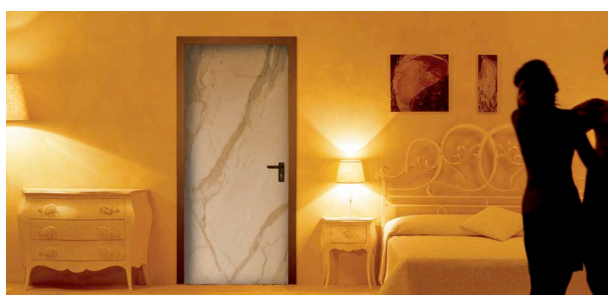

**PATTERN** Contains an infinite number of NDD decorations and textures created on customer request and available and useable for a diverse variety of applications.

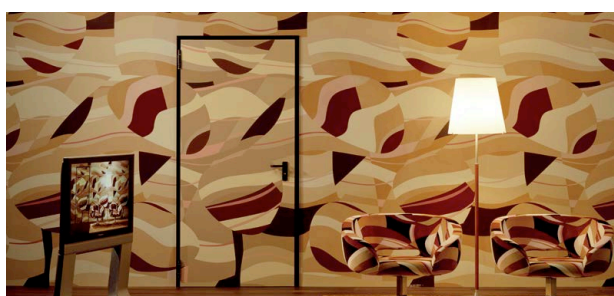

**PUBLICITY** Transforms Ninz doors into a publicity tool for the company and its products. Printing of the logo integrates the door into the company image. A variety of actual applications are reported here.



**PHOTOGRAPHS** This group contains original photos of country sides, objects, animals, environments, etc., with the appropriate foto resolution.



**SYMBOLS** Given the particular importance of this group, a special department has been created for workplace safety symbols, room description/labeling symbols, the simple numbering of rooms, etc.



## DECORATIONS FROM OUR DATABASE

Doors with decorative NDD painting are supplied with:

- doorframes in the proposed color
- door leaf rebate in the base color of the leaf itself
- hinges in the frame color
- accessories of the type and finishing according to the Ninz door price lists and brochures
- decoration covering the window frame and/or the central upright, require that these are covered with NDD decorated sheet metal

## SPECIAL DECORATIONS

New codes and pricing are required for customized decorations and decorations that employ colors not listed in this brochure. In such cases, customers may also be asked to indicate where logos and symbols should be positioned on the door leaf, via the following forms of support:

- **PC-GENERATED FILE** (logos, symbols, designs, etc.) in specialized "Illustrator" or "Freehand" format. Submit the file by e-mail or on a CD/DVD-ROM.
- **DIAPOSITIVE** with a 36 mm or 6 x 6 image of the picture uploaded to a PC using a scanner (professional scanner required). Submit the file (TIF, PDF or JPG format) in **maximum resolution** on CD/DVD-ROM.
- **PHOTOGRAPHIC IMAGE** made with a digital camera. Submit the file (TIF, PDF or JPG format) in **maximum resolution** on CD/DVD-ROM.

## PROTECTION FOR EXTERIORS

The exterior installation of NDD doors requires specific treatments for preventing the decorations from deteriorating over time. The cost supplement covers all door leaf surfaces except for the leaf rebate.

## WOODEN CRATE PACKAGING



The particularity and prestige of NDD decorations requires a special protection of the doors by packaging them in special wooden crates with an additional layer of external nylon wrapping. At the time of ordering, therefore, the additional cost for the wooden crate must be taken into consideration. Customers who opt for standard packaging on pallets must assume full responsibility in case of damage to the product.



# MORE THAN FIREDOORS

## EXAMPLE APPLICATIONS IN TYPICAL SURROUNDINGS

Airports - Train stations

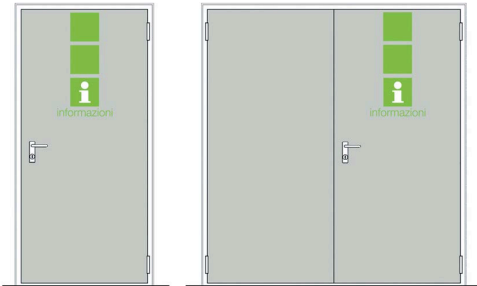

Museums – Historical buildings



Commercial businesses



Hospitals – Nursing homes

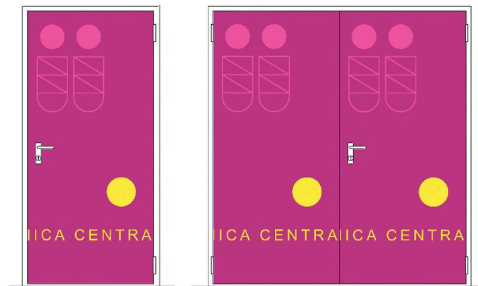

Sport centers – Stadiums

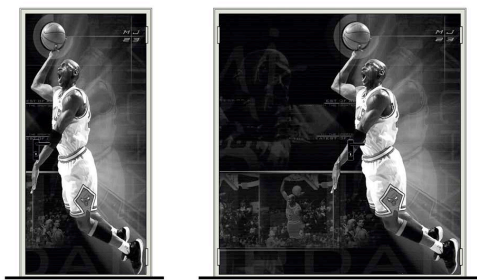

Parking lots

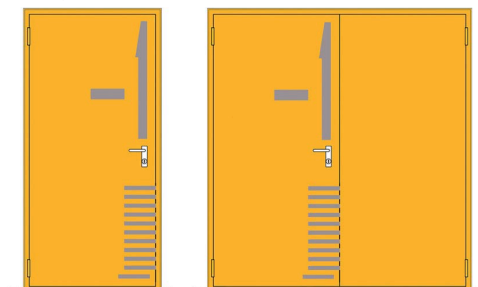

Logistic centers

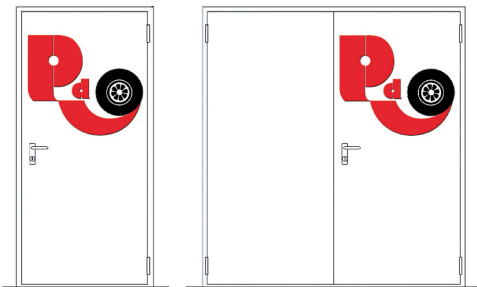

Schools - Universities

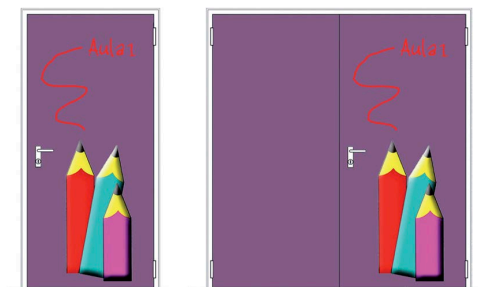

Hotels – Residences



Offices

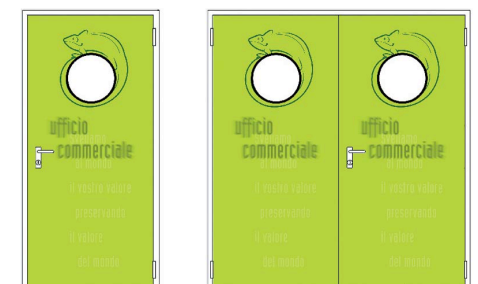

# Handles

Standard for REVER - UNIVER - PROGET doors



## BLACK PLASTIC HANDLES

By default Rever, Univer and Proget doors include safety levers coupled with long plates with cylinder holes. Each handle set includes a patent key insert, a 9 x 9mm square spindle, fastener screws and spacers.

### M1 HANDLE

The M1-type handles are supplied as standard for fire-rated Univer, all Proget type doors and, on request, for all other types of NINZ doors.

M1 handles are fire rated consisting of a metal core inside the lever and a galvanized steel cover plate to protect the cylinder hole and have been certified in accordance with DIN 18273:1997-12.

The M1 handle package includes: a pair of black plastic lever with metal cores and galvanized steel installation plates, a pair of black plastic cover plates with patent-type cylinder hole adaptable for installation of Euro profile cylinders, a 125 mm long 9 x 9 square spindle, fastener screws and spacers. The package includes also the hexagonal key for setting of the hinges and fastening of the spring screw.



M1 plastic handle

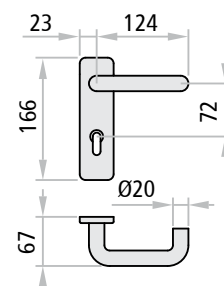

### M1R HANDLE

Multi-purpose Univer and Rever doors are equipped with M1R-type handles.

The M1R handle package includes: a pair of black plastic lever handles, a pair of black plastic cover plates with patent-type cylinder holes adaptable for installation of Euro profile cylinders, a 125 mm long 9 x 9 square spindle, fastener screws and spacers.



M1R plastic handle

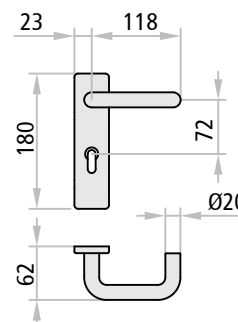

# Handles

For locks with an inter-axis distance of 72 mm

## COLORED HANDLES

On request, painted resin handles can be provided which match or provide better contrast with the base color of the door.

M1C and M2C handles are fire rated like the M1 handle, and have also been certified in accordance with DIN 18273:1997-12.

The M1C and M2C handles package consist of: one pair of lever handles (M1C) or the handle/ doorknob combination (M2C) made of plastic with a metal core and galvanized steel installation plate, a pair of plastic cover plates with a Euro profile cylinder hole, a 9x9mm square spindle, fastener screws and spacers.

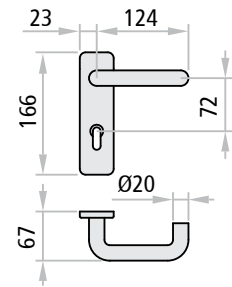

M1C handle colored RAL1023

### Colors available:

RAL	RAL	RAL	RAL	RAL
1023	7016	7035	9006*	9010

\*light aluminum

## STAINLESS STEEL HANDLES

On request, brushed stainless steel AISI 304 levers and cover plates can be provided which endow the product with a higher quality while at the same time ensuring optimal corrosion resistance and a noteworthy robustness of the entire set.

In addition, M1X, M2X, M11X and M20X handles are equipped with a return spring that maintains perfect alignment with the geometry of the door.

They are mounted on a galvanized steel mechanism and are supplied with fastener screws, spacers and a 9x9mm square spindle (where required).

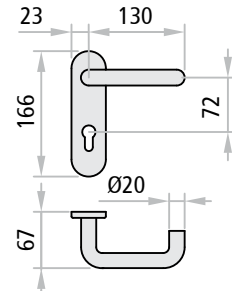

M1 stainless steel handle

### NOTE

Euro profile cylinder to be ordered separately (except for M11X and M20X handles).

Only M1C, M1X and M11X models are combinable with the three point locking mechanism.

# Handles

For locks with an inter-axis distance of 72 mm



## HANDLES

Rever, Univer and Proget doors may be equipped on request with handles with special functions other than those provided by standard handles.

Versions				description	functioning	use
	M1, M1R, M1C		M1X	handle/handle combination with cylinder hole on both sides. For combination with lock with an inter-axis distance of 72 mm (015)	door opening by handle or key from both sides	applications in which both door opening directions are accessible without key
	M2, M2C		M2X	handle/doorknob combination with cylinder hole on both sides. For combination with lock with an inter-axis distance of 72 mm (015)	the doorknob side requires the key for opening	applications in which only one of the door opening directions is accessible with a key
	M4		M4X	doorknob/doorknob combination with cylinder hole on both sides. For combination with lock with an inter-axis distance of 72 mm (015)	both sides require the key for opening. The doorknobs serve for pushing or pulling the door	applications in which both door opening directions are accessible by key only
	M5		M5X	plate/plate combination with cylinder hole on both sides. For combination with lock with an inter-axis distance of 72 mm (015)	both sides require the key for opening	applications in technical rooms with doors that usually remain closed and require key for opening
	M9		M9X	doorknob/plate combination with cylinder hole on both sides. For combination with lock with an inter-axis distance of 72 mm (015)	both sides require the key for opening. The doorknob serves for pulling the door	applications in which both door opening directions are accessible by key only
	M11		M11X	handle/handle combination without cylinder hole. For combination with lock with an inter-axis distance of 72 mm (015)	opening is possible at any time using the handle	applications in which the door never needs to be locked
	M20		M20X	handle/handle and thumbturn latch combination for interior closure. For combination with lock with star-shaped spindles only (Stel 15)	closure using thumbturn latch from inside. Emergency opening from outside with screwdriver	typical closure for bathroom doors

### NOTE

For stainless steel handle the Euro profile cylinder must be ordered separately (except for M11X and M20X handles). Only M1, M1C, M1X, M11 and M11X models are combinable with the three point locking mechanism.

## CYLINDERS

On request Rever, Univer and Proget doors with standard locks (Std 015), MAC2 system control access locks or three-point locking mechanisms (3vie PRO) may be supplied with a Euro profile cylinder with three keys. They may also be provided in unique coding or group coded versions, or in combination with unique or group mastering.

### Cylinders for handles

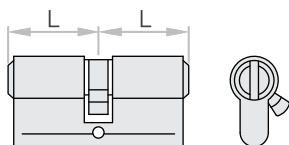

Nickel-plated cylinder equipped with 3 keys

#### Versions available

standard cylinder
single coded cylinder
group coded cylinder
sample key coded cylinder
single mastered cylinder
group mastered cylinder



Lengths available	for door leaf thickness
40/40	60 mm
35/35	50 mm
30/30	40 mm

#### ATTENTION

It is important to specify MAC lock combinations in the order.

### Cylinders with thumbturn latch

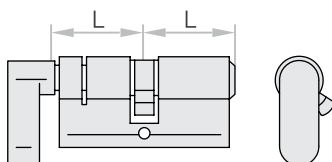

Nickel-plated cylinder with chrome-plated thumbturn latch equipped with 3 keys

#### Versions available

standard cylinder with thumbturn latch
group coded cylinder with thumbturn latch
sample key coded cylinder with thumbturn latch
single mastered cylinder with thumbturn latch
group mastered cylinder with thumbturn latch
mastered and emergency cylinder with thumbturn latch



Lengths available	for door leaf thickness
40/40	60 mm
35/35	50 mm
30/30	40 mm

#### NOTE

Cylinders to be combined with locks of NINZ doors must meet DIN 18254 standards. Main, master and/or emergency key (or keys) should be ordered separately - they are not included with the cylinder.

## CYLINDERS FOR PANIC BARS AND MSC HANDLES

Standard panic bars are supplied with a Euro profile cylinder with three keys.

Cylinders with single coding, grouped coding or in combination with single or grouped mastering.

### Cylinders to be combined with MSC handle and panic bars (except EXUS DC)

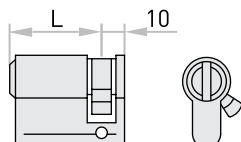

Nickel-plated cylinder equipped with 3 keys

#### Versions available

standard half cylinder
single coded half cylinder
group coded half cylinder
sample key coded half cylinder
single mastered half cylinder
group mastered half cylinder

#### Lengths available

Lengths available	for door leaf thickness
40/10	60 mm
35/10	50 mm
30/10	40 mm

#### ATTENTION

It is important to specify MAC lock combinations in the order.

### Cylinders to be combined with EXUS DC panic bars

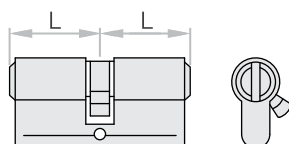

Nickel-plated cylinder equipped with 3 keys.

#### Versions available

standard cylinder
single coded cylinder
group coded cylinder
sample key coded cylinder
single mastered cylinder
group mastered cylinder

#### Lengths available

Lengths available	for door leaf thickness
45/40	60 mm
40/40	50 mm
35/35	40 mm

#### NOTE

Cylinders to be combined with the locks of NINZ doors must meet DIN 18254 standards.

Main, master and/or emergency key (or keys) should be ordered separately - they are not included with the cylinder.



## CONFIGURED AS NEEDED!

NINZ asks its partners to specify the system in the form of a key plan which, when prepared with care, serves as a map for optimizing the required intervention times (from order to installation) while ensuring that the mastering system meets the specific needs being requested.

Here are a few of the configurations that are available:

### 1) Standard

Cylinders with different keys.

### 2) Single coded

Cylinders with the same keys.

### 3) Grouped coded

Cylinders from the same group are coded alike.

### 4) Main/master key systems

Grouped master key system in which each cylinder can be opened with its own key or with a master key that can open cylinders from one group but not others; a general master key can open all cylinders from all different groups. Standard cylinders closed from the interior with a thumb-turn latch cannot be opened with the main/master key.

### 5) Frictioned emergency

"Frictioned cylinder" means that the main or master key can only open doors that have not been closed from inside, while the same doors can still be opened with the emergency key.

### 6) Encrypted with sample key

Sample key coding allows for cylinders to be coded on the basis of a sample key supplied by the customer.

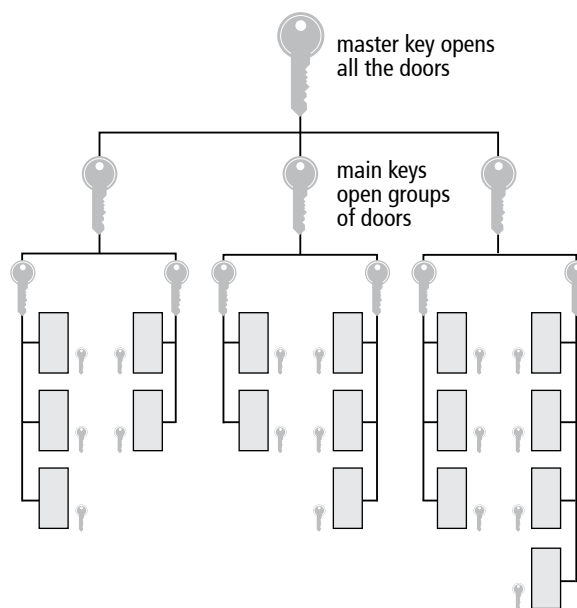

Key plan example for master key systems.

## KEYS

The order should specify the number of keys to be supplied with the mastered cylinders.

### Versions available

normal key	opens the single door only
main key	opens all doors from the same group
master key	opens all the doors that have grouped mastering
emergency key	opens all doors



Key

# Door closers

For REVER - UNIVER - PROGET doors

REVER  
multipurpose

## DOOR CLOSER

The door closer regulates the closure of the door so that the door leaf returns properly to its final closed position after being released. Regulation is influenced by closure force, speed and the final impact. Although Univer and Proget doors are equipped with spring hinges for automatic closure, the installation of door closers is recommended for wide and/or heavy doors and/or in the presence of windows on the leaf. The door closer product is addressed by EU directive 89/106/CEE, which means it is subject to CE marking.

### CP1 with scissor arm

CE marked in conformity with EN 1154. Rever, Univer and Proget doors are available, on request, with an overhead CP1 door closer with a silver-colored scissor arm. The silver-colored CP1-G door closer is available for Proget doors, for installation on the push side of the door. The CP1/CP1-G can be used for fire rated doors and is classified for 180° closure with a force varying from 3 to 4. Proget doors ordered with CP1 are provided with pre-drilled installation holes on the door leaf and the frame. Standard Univer and Proget doors include internal reinforcements for the CP1 application.

**NOTE**  
Arm protrusion = 290 mm

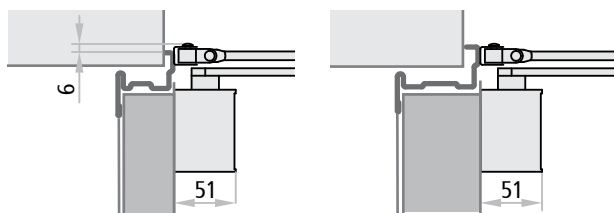

CP1 REVER                      CP1 UNIVER



**Optional colors (except CP1-G):**  
dark bronze    RAL 9016    RAL 9005

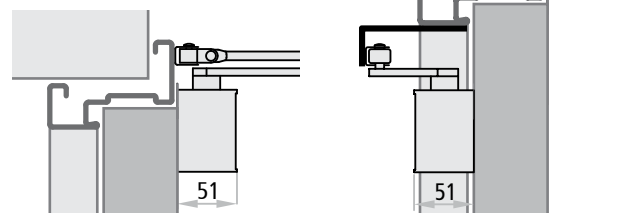

CP1 PROGET (from pull side)                      CP1-G PROGET (from push side)

### CP2 with slide channel

CE marked in conformity with EN 1154. On request Rever, Univer and Proget doors are available with an overhead CP2 door closer with slide channel. Relative to the CP1, the advantage of this system is the absence of a protruding of scissor arm. The CP2 is suited for use on fire rated doors and has been classified for 180° closure with force level 4. The silver-colored CP2-G door closer is available for Proget doors, for installation on the push side of the door, with force level 3. Minimum wall opening width of 1200 mm for two leaved doors with two CP2/CP2-G applied. Proget doors ordered with CP2 are provided with pre-drilled installation holes on the door leaf and the frame. Standard Univer and Proget doors include internal reinforcements for the CP2 application.

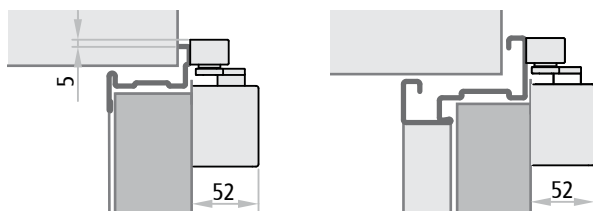

CP2 UNIVER                      CP2 PROGET



**Optional colors (except CP2-G):**  
dark bronze    RAL 9016    RAL 9005

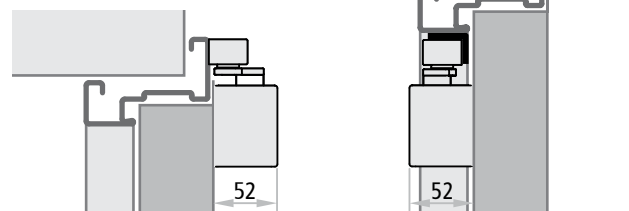

CP2 PROGET (from pull side)                      CP2-G PROGET (from push side)

# Automatic door sweep

For NINZ doors



## AUTOMATIC DOOR SWEEP

On request, Rever, Univer and Proget doors are available with an automatic door sweep to prevent air drafts from entering through the crack between the leaf and the floor. It complements the FF sealing applied to the frame to provide better acoustic insulation and better air sealing for the door.

It is applied on the push side by using screws to attach it directly to the sheet metal of the door, after which the mechanism is completely covered with an anodized aluminum profile.

On request, it can also be provided in the same color as the door leaf. It is applied on site following door installation so that it can be adjusted to the actual leaf height.

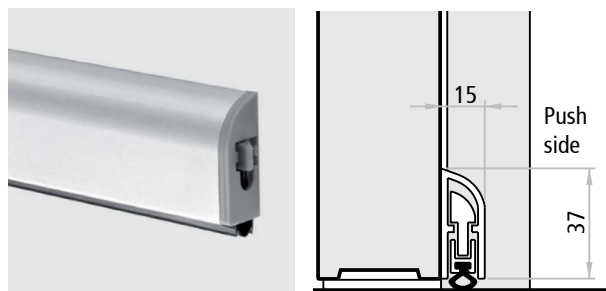

REVER multipurpose

## FIELDS OF APPLICATION FOR THE AUTOMATIC DOOR SWEEP

### REVER and UNIVER multipurpose doors

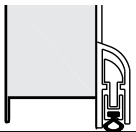
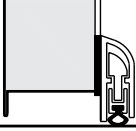
	FM L one-leaved door	L1 active leaf	L2 inactive leaf with 30x4mm profile	seals to be used
 1 leaf/active	from 500 to 513 mm	from 500 to 521 mm	from 400 to 431 mm	L 430 mm
	from 514 to 613 mm	from 522 to 621 mm	from 432 to 531 mm	L 530 mm
	from 614 to 713 mm	from 622 to 721 mm	from 532 to 631 mm	L 630 mm
 inactive leaf with 30x4mm profile	from 714 to 813 mm	from 722 to 821 mm	from 632 to 731 mm	L 730 mm
	from 814 to 913 mm	from 822 to 921 mm	from 732 to 831 mm	L 830 mm
	from 914 to 1013 mm	from 922 to 1000 mm	from 832 to 931 mm	L 930 mm
	from 1014 to 1113 mm		from 932 to 1000 mm	L 1030 mm
	from 1114 to 1213 mm			L 1130 mm
	from 1214 to 1313 mm			L 1230 mm
	from 1314 to 1350 mm			L 1330 mm

# Drip-steel profile - Protective plates

For NINZ doors



REVER  
multipurpose

## DRIP-STEEL PROFILE

On request for Univer and Proget one-leaved doors. Normally used to prevent condensation from dripping down the door leaf and puddling beneath the door. The profile is made of "Sendzimir" processed galvanized sheet metal painted the color of the door leaf.

It is applied usually on the push side of the leaf on site after being cut to measure, to be attached with the screws provided.

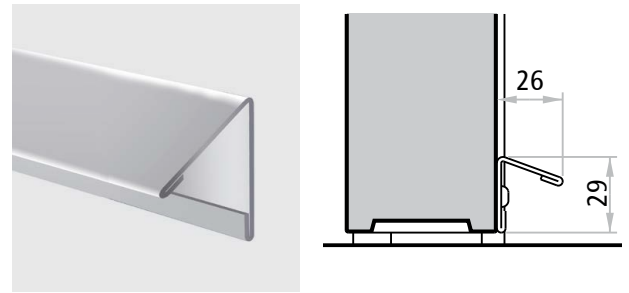

Lengths available	FM L door leaf
828 mm	to 800 mm
928 mm	to 900 mm
1028 mm	to 1000 mm
1378 mm	to 1350 mm

## PROTECTIVE PLATES AND KICKPLATES

On request for 1 and 2 leaf Univer and Proget doors, specifying the side of application (pull or push).

Their main function is to protect the parts of the door that are vulnerable to being scraped by carts, hospital beds, etc.

They are made of AISI 304 brushed stainless steel sheet metal with a standard height of 230 mm.

For on-site attachment with two-sided adhesive factory applied on the back, at the bottom of the door (kick plate) or at handle height (protective plate).



Holes are factory prepared for the passage of the handle panel and cylinder

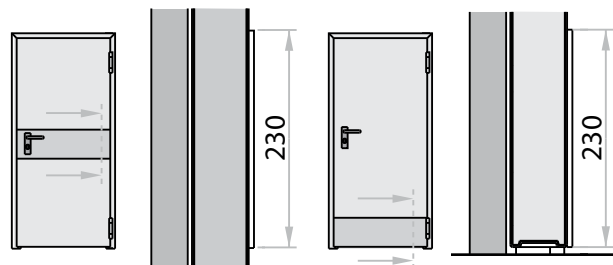

Protection plates

Kick plates



Example of application on the push side

# MAC® Multifunctional Access Control

## Controlled opening system

Installation on the door of MAC and MAC FAILSAFE systems allows to control access by electric impulse. The particularity of the MAC and MAC FAILSAFE system is to integrate all command and control functions in the lock, which simplifies the electrical works required on site.

### Differences between MAC and MAC FAILSAFE systems:

- the MAC systems, in the event of a power failure, allow the opening only via key or panic/emergency exit device. Thus MAC systems are recommended in situations where the door shall remain closed, even in case of power failure.
- the MAC FAILSAFE systems guarantee access in the situation of power failure. Thus MAC FAILSAFE systems are recommended in situations where free passage must be assured, even in case of power failure.

### The MAC system offers multiple advantages, such as:

- possibility of 12 or 24V AC/DC power supplies, which avoids problems due to inadequate voltage
- *low current absorption:*
  - at 12V the startup current is 500mA for the first 5-6 sec., before changing to a 250mA maintenance current
  - at 24V the startup current is 1A for 300 millise., before settling to 500mA for 4-5 sec. and finally changing to a 250mA maintenance current for the remaining 25 sec.
- timer incorporated, time set at 30 sec., eliminating the need for external timers. Further, in case of delivery with the door with automatic reset function (reset of the timer) for every door opening
- red/green LED on the cover plate to prevent useless forcing of the handle by signaling whether the opening system is active or not
- possibility of continuous handle activation (always open when desired)
- ready for the connection of an optional remote LED (not supplied) for remote signaling of lock activation/deactivation
- guaranteed access in case of power failure (only for FAILSAFE version)

The MAC and MAC FAILSAFE systems can be delivered installed onto the door with internal wiring through the leaf and electrical contacts between the leaf and the doorframe. The KIT includes a flexible cable sleeve and the electrical cables are to be installed externally.

### NOTE

Before the installation of doors with MAC locks it is necessary to prepare the power supply (active door leaf side in case of double leaved doors) at a height of approx. 800mm from the finished floor level and in proximity of the wall angle, where the door frame will be mounted. The power wires must have a section of 0,75-1,0mm<sup>2</sup> and must be flexible.



Plastic handle with LEDs



Stainless steel handle with LEDs



Double electrical contacts between leaf and doorframe

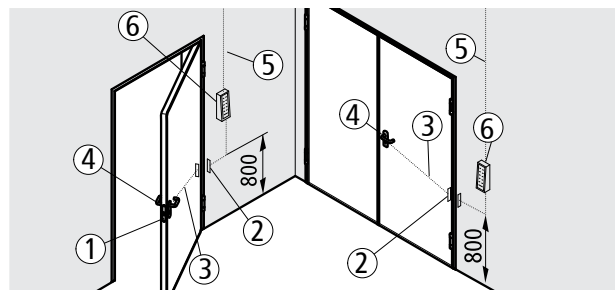

Diagram of components

*Delivery together with the door features these installed accessories: lock with solenoid and electronic chip with timer incorporated (1), double electrical contacts between leaf and frame (2), internal wiring inside the leaf (3); supplied to be installed: handle and cover plate with red/green LED and connectors (4). Not included: power supply for doorframe contacts (5), opening button and command accessories (6).*

*Unlike the delivery together with the door, the KIT (supplied separately from the door) offers a flexible cable sleeve between the door leaf and the power supply instead of the double electrical contacts. In case of a handle the installation of a cable duct onto the door leaf (not supplied) is necessary for the power supply.*

## MAC1 AND MAC1 FAILSAFE SYSTEM

### Door opening in case of power failure (LED off)

- MAC1: from pull side only by key; from push side by panic bar or emergency handle.
- MAC1 FAILSAFE: from pull side by handle (or key); from push side by panic bar or emergency handle.

### Operating mode

The system controls access from the pull side of the door. With the lock locked by key, the access consent is possible via electric impulse (button, badge reader, etc.), which gives power supply in case of MAC1 or it turn off in case of MAC1 FAILSAFE, while opening is always possible from the push side by means of the panic bar or emergency handle. Activation of the handle is signaled by illumination of the "green LED," while the "red LED" indicates when the handle is idle. Both LEDs are off when no power is being supplied.

### Timed function

In this mode, the activation time lasts 30 seconds before the handle is returned to idle. In case of delivery with the door, if the door is opened within the 30 seconds, the timer is automatically reset to zero.

### Continuous "day time" function

In this mode the handle is continuously enabled by an electric switch (not supplied) for a longer period (for example during the day), which keeps the lock always enabled. The green LED remains switched on (not valid for the "Kit" version) and is switched off only for the period between the door's opening and its fully closure.

**MAC1 can be combined with any BM type panic bar and M3 emergency handles (to be ordered on the side).**

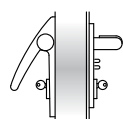

EX DC BM

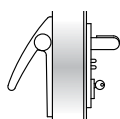

EX/TW BM

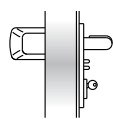

SL BM

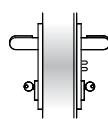

M3

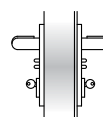

M1

## MAC2 AND MAC2 FAILSAFE SYSTEM

### Door opening in case of power failure (LED off)

- MAC2: from both sides by key only.
- MAC2 FAILSAFE: from both sides by handle (or key).

### Operating mode

The system controls access from both sides of the door. With the lock locked by key, the access consent is possible via electric impulse (button, badge reader, etc.), which gives power supply in case of MAC2 or it turn off in case of MAC2 FAILSAFE. Activation of both handles is signaled by illumination of the "green LED," with the "red LED" signaling when the handles are idle. Both LEDs are off when no power is being supplied.

### Timed function

In this mode, the activation time lasts 30 seconds before both handles are returned to idle. In case of delivery with the door, if the door is opened within the 30 seconds, the timer is automatically reset to zero.

### Continuous "day time" function

In this mode both handles are continuously enabled by an electric switch (not supplied) for a longer period (for example during the day), which keeps the lock always enabled. The green LEDs remain switched on (not valid for the "Kit" version) and are switched off only for the period between the door's opening and its fully closure.

**MAC2 standard delivery with M1 plastic handle. Upon request an M1X stainless steel handle can be delivered (to be ordered on the side).**

## MAC3 AND MAC3 FAILSAFE SYSTEM

### Door opening in case of power failure (LED off)

- MAC3: from push side only by key; from pull side by the M3tir/M3Xtir emergency handle.
- MAC3 FAILSAFE: from push side by handle (or key); from pull side by the M3tir/M3Xtir emergency handle.

### Operating mode

The system controls access from the push side of the door. With the lock locked by key, the access consent is possible via electric impulse (button, badge reader, etc.), which gives power supply in case of MAC3 or it turn off in case of MAC3 FAILSAFE, while opening is always possible from the pull side by means of the emergency handle. Activation of the handle is signaled by illumination of the "green LED," while the "red LED" indicates when the handle is idle. Both LEDs are off when no power is being supplied.

### Timed function

In this mode, the activation time lasts 30 seconds before the handle is returned to idle. In case of delivery with the door, if the door is opened within the 30 seconds, the timer is automatically reset to zero.

### Continuous "day time" function

In this mode the handle is continuously enabled by an electric switch (not supplied) for a longer period (for example during the day), which keeps the lock always enabled. The green LED remains switched on (not valid for the "Kit" version) and is switched off only for the period between the door's opening and its fully closure.

**MAC3 standard delivery with M3tir plastic handle. Upon request an M3Xtir stainless steel handle can be delivered (to be ordered on the side).**

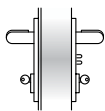

M3tir

### NOTE

Before the installation of doors with MAC locks it is necessary to prepare the power supply (active door leaf side in case of double leaved doors) at a height of approx. 800mm from the finished floor level and in proximity of the wall angle, where the door frame will be mounted. The power wires must have a section of 0,75-1,0mm<sup>2</sup> and must be flexible.

# Electric handles

## Controlled opening system

### ELM/MT MULTI-VOLTAGE ELECTRIC HANDLE

Controlled door opening system that employs an electronic device to activate the handle. The latter is equipped with an internal timer with a 30 seconds time allowance for opening the door, after which the electric handle is deactivated. The handle can be activated for longer time periods by means of the electrical switch. The illumination of a green LED and sounding of an acoustic signal (buzzer) indicate handle activation, while a red LED indicates deactivation.

**When ordered together with the door, the ELM/mt system includes:**

electric handle, electrical contacts between the leaf and the frame, power cable inside the door connected to electrical contacts, command panel, lock and fixing screws.

**If ordered separately from the door, the system includes:**

electric handle, command panel and fixing screws.

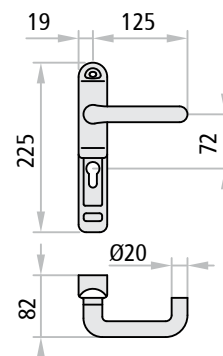
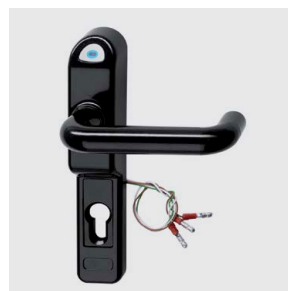

#### Technical data

power supply	12-24V AC/DC
current absorbed	at 12 V: 500 mA - at 24 V: 200 mA
startup current	at 12 V: 700 mA - at 24 V: 300 mA
minimum operating temperature	-5°C

### ELM/CISA MULTI-VOLTAGE ELECTRIC HANDLE

Controlled door opening system that employs an electronic device to activate the handle. Equipped with a separate timer (for insertion into the switch box) which can be set for different opening times: from a minimum of 0,1 second to a maximum of 10 days. Equipped with green LED that signal activation of the handle.

The ELM/cisa system includes: electric handles, 2 meters of power cable, cable sleeve for the connection between the leaf and the frame, 8/9 square spindle, fixing screws, adjustable timer packaged separately.

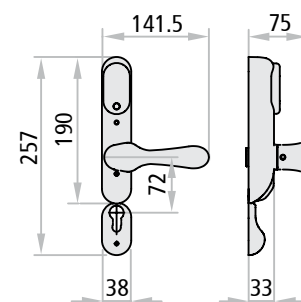
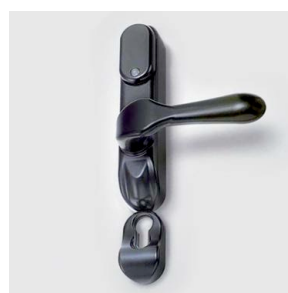

#### Technical data

power supply	12-24V AC/DC
current	absorbed: 360 mA - startup: 800 mA
operational temperature	-20°C ÷ +80°C

### PANIC BARS FOR COMBINATION WITH ELM/MT OR ELM/CISA ELECTRIC HANDLES

The controlled opening direction is from the pull side of the door (electric handle side). Locking the lock by key blocks the electric handle functioning, while opening is still possible via the panic bar on the push side.

Use: one- or two-leaved doors for anti-panic exits when access control is desired on the pull side.

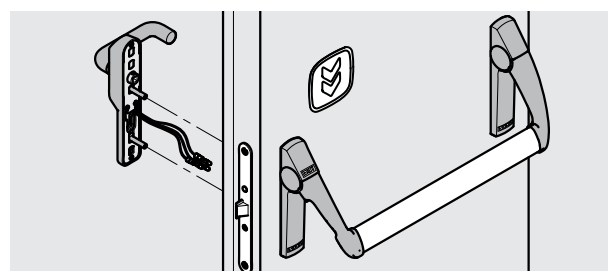

Exus

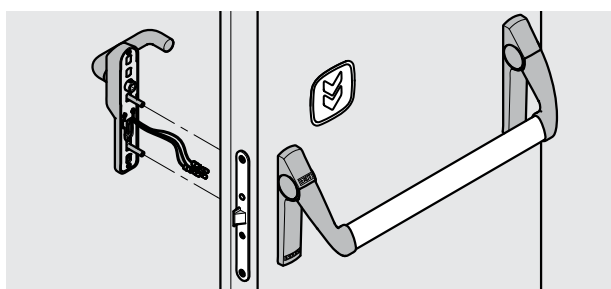

Twist

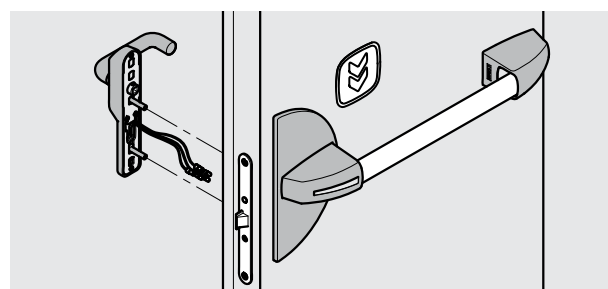

Slash



# Electric handles - Electromagnetic sensor

## Controlled opening system



REVER  
multipurpose

### HANDLES FOR COMBINATION WITH ELM/MT OR ELM/CISA ELECTRIC HANDLES

#### MSC, MSC-X

Use: one- or two-leaved doors when control is desired for one of the two opening directions. Locking with the key blocks opening in both directions.

Controlled opening may be for either the push or pull direction, depending on where the electric handle is applied.

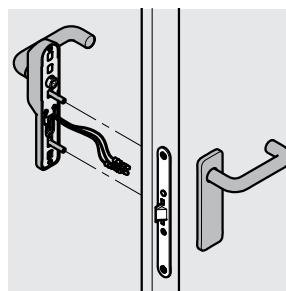

MSC

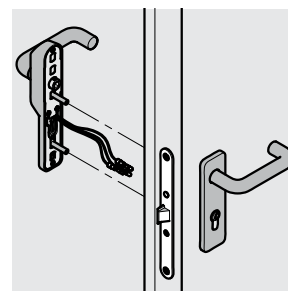

MCC/S

#### MCC/S, MCC/S-X

Use: for one- or two-leaved doors where access is to be controlled from the pull side only (electric handle side). Locking with the key blocks opening from the push side, but not from the side where the electric handle is applied.

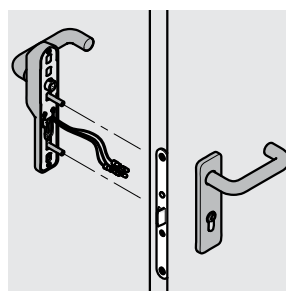

MCC/T

#### MCC/T, MCC/T-X

Use: for one- or two-leaved doors where access is to be controlled from the push side only (electric handle side). Locking with the key blocks opening from the pull side, but not from the side where the electric handle is applied.

### EMERGENCY HANDLES FOR COMBINATION WITH ELM/MT ELECTRIC HANDLE

#### M3, M3X

Use: one- or two-leaved doors for emergency exits when access control is desired on the pull side.

The controlled opening direction is from the pull side of the door (electric handle side). Locking the lock by key blocks the operation of the electric handle, while opening remains possible via the M3 or M3X emergency handle.

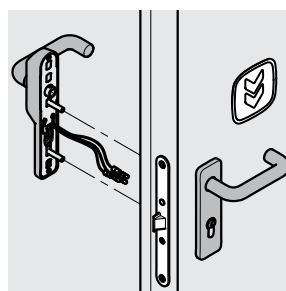

M3

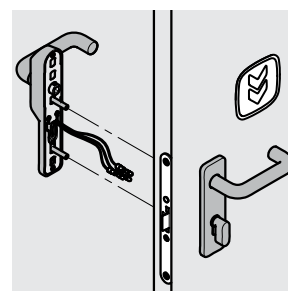

HOT-CIL

#### HOT-CIL, HOT-CIL-X

Use: for hotel rooms doors.

The controlled opening direction is from the push side of the door (electric handle side). Opening from push side is possible with an electric consent at the electric handle. Opening is always possible from the room side of the door via the HOT-CIL or HOT-CIL-X emergency handle, also in case of lock locked by thumbturn latch.

### ELECTROMAGNETIC SENSOR

The electromagnetic sensor allows to verify the position of the door leaf. To be applied to the door, composed of two elements: one electromagnetic sensor with two cables and one magnet.

#### Technical data

maximum voltage	200 V DC / 500 mA with resistive load
internal switch contact	n.o. (n.c. with magnet aligned)
operational temperature	+5 / +40 °C

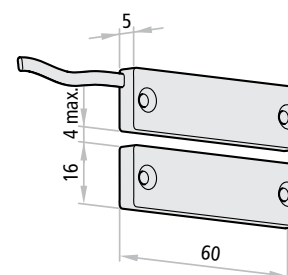

# Door blocking electromagnet

## Controlled opening system

### DOOR BLOCKING ELECTROMAGNET

This system is for use in special situations when the doors remain closed and should only be opened with electrical consent. The electrically powered electromagnet holds the door closed with a holding force of approximately 300kg, rendering the action of the handle ineffective. Only electrical commands (badge reader, key button, etc.) or electrical consent from the fire detector system can deactivate the electromagnet making a door opening possible.

#### Operating mode

The door is held closed by the electromagnet (01) and the bolt of the lock. Opening from the outside can happen via magnetic card (04) using the Badge reader (02) of the card control system or any other system of choice and by retracting the bolt using the handle or key.

From the inside, the deactivation of the electromagnet is caused by the unlock button (03) (also remotely) or with the same system used for the pull side, while the locking bolt must still be retracted using the handle or key. The activated electromagnet signals its state with a red LED, whereas the green LED signals the temporary deactivation. Further a relay AC/DC signaling the electromagnetic state is supplied.

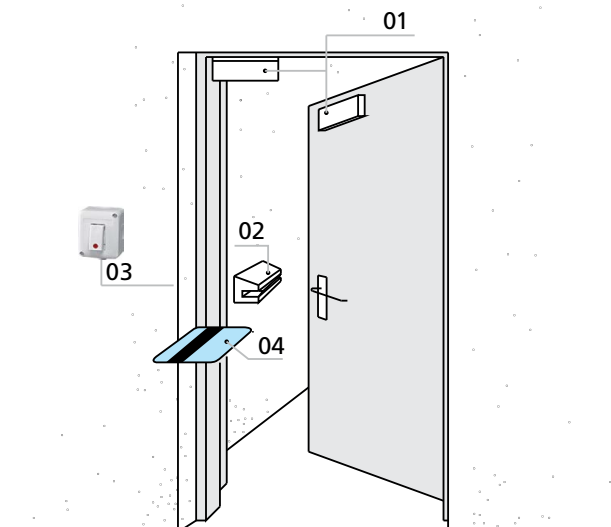

**NOTE**  
Unlocking of the door is only possible if the door is not locked by key.

#### Technical data

power supply	12/24V DC	time delay	0 ÷ 90 sec.
current absorbed	500mA at 12V DC - 250mA at 24V DC	electromagnetic compatibility standard	EMC - UNI CEI 70011
force	up to 300kg.	certificate Nr.	0123/02

### COMPONENTS INCLUDED WITH THE DOOR BLOCKING ELECTROMAGNET

#### For Proget doors

Door blocking electromagnet, withstanding force 300kg, 12/24V DC, fastener plate, anchor with stainless steel fastener backplate.

#### For Rever/Univer doors

Door blocking electromagnet, withstanding force 300kg, 12/24V DC, fastener plate and angle bar, anchor with stainless steel fastener backplate.

#### Control system:

- "Access" code keypad
- Card-based control system
- Biometric fingerprint reader
- Unlock button

#### NOTE

Detailed specifications for the Control system are found on the "Command accessories" page.



PROGET electromagnet



REVER/UNIVER electromagnet

## CONTROL SYSTEMS AND RELATED ACCESSORIES

### “Access” code keypad

Keypad with 10 numeric buttons plus an Enter key, including control unit for 1 door, timer incorporated (0,5÷25 sec.) and flat cable. Up to 500 recordable different codes, composed from 1 to 10 digits.

#### Technical data

power supply	12 ÷ 18 V AC/DC
output	relay

### Card-based control system

Card control system, including control unit for 1 door, timer and AC adapter incorporated, badge reader, flat cable, three blank badges and a coded badge. Management of access control for multiple doors by P.C.

#### Technical data

power supply	230 V AC
output	12 V DC, max. 0,5 A

### Biometric fingerprint reader

Biometric reader for reading of fingerprints and transformation into key codes. Includes an internal unit for registering, memorizing and cancelling users, external unit for the reading of fingerprints and an autonomous low voltage AC adapter. The power supply for the management of the door is not included.

#### Technical data

power supply	230 V AC
output	relay

### Unlock button

Unlock button with white casing and control light.

### Power supply Switching

Can be combined with “Access code keypad”, with “Biometric fingerprint reader” and for the management of:

- max. Nr. 10 MAC® Multifunction Access Control \*
- or max. Nr. 5 Electromagnets door blocking
- or max. Nr. 5 ELM/mt Electric handles \*
- or max. Nr. 8 ELM/cisa Electric handles \*

\* provided that they are not commanded simultaneously

#### Technical data

power supply	230 V AC
output	12 V DC - 3 A

#### NOTE

It is possible to wire a couple of buffer batteries to the power supply switching (see “Door-holding systems”).



„Access“ code keypad

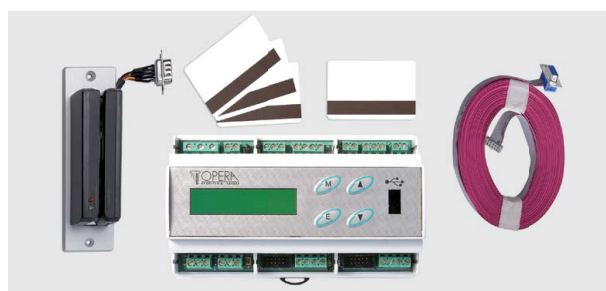

Card-based control system



Biometric fingerprint reader



Unlock button



Power supply switching

# Emergency handles

NINZ

REVER  
multipurpose

**"safety is in  
your hands"**



## PRESENTATION

### Emergency exit devices (emergency handles)

Ninz S.p.A. is a leader in fire doors, and has once again re-asserted itself as a visionary company with a strong identity created by its continuous research into the design and technology of its own products, such as the new line of emergency exit handles.

The handles are **CE** marked and pre-certified according to European standard EN 179:2008, which entered in effect January 01, 2010, and which prescribes a several substantial changes that further extend the requirements for maximum safety and ease of opening.

### The Kit designed for your needs

When ordered separately from the door, the M3, M3X, M14, M14X, Hot CIL and HOT CIL-X handles are packaged in functional KITS for display and presentation in the most appropriate distribution context.

Packaging in KITS ensures customers, installers and therefore the final users that they are receiving a complete anti-panic system with fully corresponding and **CE** certified parts.

### Certifications and replacements

Given the importance of maintaining the entire system's **CE** conformity, special attention has been paid to replacement parts, which have been subjected to testing in accordance with the EN 179:2008 standard due to their pivotal role in maintaining **CE** certification.

The only way to ensure that the products maintain their original characteristics over time is by using original NINZ replacement parts.

For this reason, the instructions for emergency handles include additional indications regarding proper installation and maintenance plus an exploded assembly drawing that specifies every smallest detail of the certified system with all of the references required for ordering replacement parts.

# M3 emergency handle

Emergency handle for internal locks - EN 179:2008

## M3 IN BLACK PLASTIC

### Description

Lever handle for emergency exit:

- Reversible for right or left opening
- Applicable to single leaf doors or the active leaf (main leaf) of two-leaved doors located at emergency exits
- Suitable for Rever/Univer/Proget doors and other types of emergency exit doors
- Both the levers and the cover plates are made of black plastic, and the core of the lever and the installation plate are made of galvanized steel
- The lock is anti-panic/fire rated for European profile cylinders
- Cylinder to pass in nickel-plated brass with 3 keys
- Suitable for doors with dimensions up to 1350 x 2880mm/leaf, mass up to 300kg/leaf, with ratings up to EI<sub>2</sub>120 - REI120 and smoke resistance, handle protrusion of 67mm

### Use

The M3 lever handle for emergency exits is for use on doors designated for emergency situations involving people who are accustomed to using safety exits and their hardware, and who are therefore unlikely to be in a state of panic.

### Operating mode

With the lock locked by key, the door can no longer be opened from the pull side, while the door can still be opened using the lever on the push side.

## VERSIONS AVAILABLE

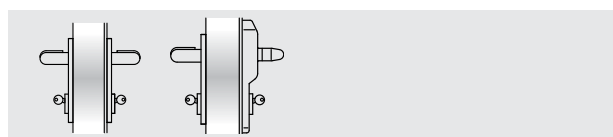

M3

M3 ELM/mt

## VARIATIONS ON REQUEST

- MAC1 type panic lock, including access control mode
- Panic lock with 3 closing points (for multipurpose PRO-GET doors only)
- Mastered or coded cylinders

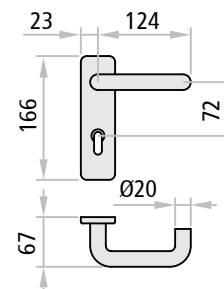

## SUPPLIED TOGETHER WITH THE DOOR

### For single leaf or the active leaf of two-leaved doors:

*Included (mounted on the door):* anti-panic lock with 65mm entrance and the strike box insert.

*Included (in the package):* Nr. 2 black plastic lever handles, Nr. 2 galvanized steel installation plates, Nr. 2 black plastic cover plates, Nr. 1 split square spindle, Nr. 1 standard nickel-plated cylinder to pass with 3 keys, Nr. 1 adhesive pictogram (green arrow), Nr. 1 instruction/maintenance manual.

*Versions available:* M3, M3 ELM/mt.

*ELM electric handle:* see the dedicated pages

## M3 KIT VERSION

### (SUPPLIED SEPARATELY FROM THE DOOR)

### KIT for single leaf or the active leaf of two-leaved doors:

Specify the leaf thickness in the order.

*KIT contents:* Nr. 1 anti-panic lock with 65mm entrance, Nr. 1 strike box insert, Nr. 2 black plastic lever handles, Nr. 2 galvanized steel installation plates, Nr. 2 black plastic cover plates, Nr. 1 split square spindle, Nr. 1 standard nickel-plated cylinder to pass with 3 keys, Nr. 1 adhesive pictogram (green arrow), Nr. 1 instruction/maintenance manual.

*Versions available:* M3

# M3X emergency handle

Emergency handle for internal locks - EN 179:2008

## M3X IN STAINLESS STEEL

### Description

Lever handle for emergency exit:

- Reversible for right or left opening
- Applicable to single leaf doors or the active leaf (main leaf) of two-leaved doors located at emergency exits
- Suitable for Rever/Univer/Proget doors and other types of emergency exit doors
- The levers as well as the cover plates are made of AISI 304 brushed stainless steel, and the installation plates are made of galvanized steel
- The lock is anti-panic/fire rated for Euro profile cylinders
- Cylinder to pass in nickel-plated brass with 3 keys
- Suitable for doors with dimensions up to 1350 x 2880mm/leaf, mass up to 300kg/leaf, with fire resistance up to EI<sub>2</sub>120 - REI120 and smoke resistance, handle protrusion of 67mm

### Use

The M3X emergency exit handle are to be applied on doors designated for emergency situations in which the people involved are accustomed to using safety exits and their opening devices, and therefore who are very unlikely to be in a state of panic.

### Operating mode

With the lock locked by key, the door can no longer be opened from the pull side, but the door can still be opened from the push side using the handle.

## VERSIONS AVAILABLE

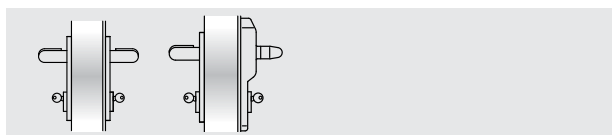

M3X

M3X ELM/mt

## VARIATIONS ON REQUEST

- MAC1 panic lock, including access control system
- Panic lock with 3 closing points (for multipurpose PRO-GET doors only)
- Mastered or coded cylinders

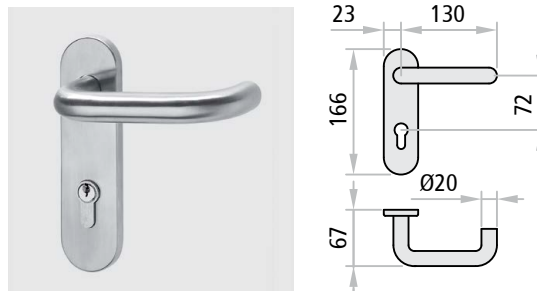

## SUPPLIED TOGETHER WITH THE DOOR

### For single leaf or the active leaf of two-leaved doors:

*Included (mounted on the door):* anti-panic lock with 65mm entrance and the strike box insert.

*Included (in the package):* Nr. 2 lever handles in brushed stainless steel, Nr. 2 galvanized steel installation plates, Nr. 2 cover plates in brushed stainless steel, Nr. 1 split square spindle, Nr. 1 standard nickel-plated cylinder to pass with 3 keys, fastener screws, Nr. 1 adhesive pictogram (green arrow), Nr. 1 instruction/maintenance manual.

*Versions available:* M3X, M3X ELM/mt.

*ELM electric handle: see the dedicated pages*

## M3X KIT VERSION

### (SUPPLIED SEPARATELY FROM THE DOOR)

### KIT for single leaf or the active leaf of two-leaved doors:

Specify the leaf thickness in the order.

*KIT contents:* Nr. 1 anti-panic lock with 65mm entrance, Nr. 1 strike box insert, Nr. 2 lever handles in brushed stainless steel, Nr. 2 galvanized steel installation plates, Nr. 2 cover plates in brushed stainless steel, Nr. 1 split square spindle, Nr. 1 standard nickel-plated cylinder to pass with 3 keys, fastener screws, Nr. 1 adhesive pictogram (green arrow), Nr. 1 instruction/maintenance manual.

*Versions available:* M3X

# Certifications

## Emergency handle for internal locks - EN 179:2008



### M3, M3X CERTIFICATIONS

Suitable for one-leaved doors or the active leaf of two-leaved doors with dimensions up to 1350x2880mm/leaf and a mass up to 300kg/leaf.

<b>Denomination</b>	M3, M3X DEVICE FOR EMERGENCY EXITS
<b>Manufacturer</b>	Ninz S.p.A. Corso Trento, 2/A I-38061 ALA (TN)/ITALY
<b>Year application trademark</b>	10
<b>Nr. and year of the standard</b>	EN 179:2008
<b>Certifying body</b>	0425
<b>CE certificate Nr.</b>	2147-CPD-2010
<b>Classification</b>	<b>3 7 7 B 1 4 4 2 A A</b>

- 1st Category of use very frequent
- 2nd Durability 200.000 cycles
- 3rd Door mass over 200 kg
- 4th Suitable for fire/smoke rated doors
- 5th Safety, suitable for evacuation routes
- 6th High corrosion resistance 240 h
- 7th Material safety 1000 N
- 8th Handle protrusion up to 100 mm
- 9th Activation type with lever handle
- 10th Suitable for one- or two-leaved doors

<b>ATTESTATO DI CONFORMITÀ</b> DIRETTIVA 89/106/CEE <b>CERTIFICATE OF CONFORMITY</b> DIRECTIVE 89/106/CEE		 0425	
<small>Questo certificato è rilasciato in conformità a quanto prescritto dall'Art.6 par.2 lettera b) del DPR 21 aprile 1993, n°246 (Direttiva 89/106/CEE) ed attesta la conformità del prodotto di seguito identificato agli Art.1, Art.2 ed allegato A del DPR 21 aprile 1993, n°246 (Direttiva 89/106/CEE).                      This certificate is issued in accordance with the requirements defined in Article 6 par.2 lett. B) of DPR 21th April 1993, n° 246 (89/106/CE Directive) and certifies the compliance of the product to art. 1, art. 2 and annex A of DPR 21th April 1993, n°246 (89/106/CE Directive)</small>			
<b>ATTESTATO N°</b>	<b>2147 - CPD - 2010</b>	<b>CERTIFICATE N°</b>	
<b>Organismo notificato</b>	<b>Notified Body</b>		
ICIM S.p.A. - Piazza Don Mapelli, 75 - 20099 SESTO SAN GIOVANNI	Identification number: 0425		
<b>Dati Fabbricante</b>	<b>Manufacturer details</b>		
Sede legale Unità operativa	NINZ S.p.A. Corso Trento, 2/A 38061 ALA (TN) ITALY	Head office Production unit	
<b>Dati prodotto</b>	<b>Product details</b>		
Tipologia	DISPOSITIVI PER USCITE DI EMERGENZA AZIONATI MEDIANTE MANIGLIA A LEVA O PIASTRA A SPINTA <b>EMERGENCY EXIT DEVICES OPERATED BY A LEVER HANDLE OR PUSH PAD</b>		
Denominazione	Dispositivo di emergenza serie "M3" "M3X"	Denominazione	
Serrature antipanico	art. AP16/18, 3201001.018, SCA 1 3201001.019/020, MAC 1 3201001.041/042		
Coppia di deviatori	art. 4201010		
Riscontro serratura	art. 2401006, 2401005, 2401015, 2401014, 2401035, 3412001		
Aste verticali	art. 3305013		
Comandi	art. 3101001.009 (M3), 3101017.003 (M3X)		
Sistema di attestazione della conformità	1	System of attestation of conformity	
Norma di riferimento	EN 179:2008	Standard reference	
Classificazione	3   7   7   B   1   4   4   2   A   A		
<b>Eventuali estensioni</b>	Nessuna / None		
<b>Eventuali condizioni di subordinazione della Certificazione CE</b>	Nessuna / None		
<small>Il presente attestato è valido esclusivamente per il prodotto indicato. Eventuali varianti da apportare devono essere approvate da ICIM SpA.                      The present certificate is valid only for the product described above. Every change has to be approved by ICIM S.p.A.</small>			
<b>Data di emissione</b> Issue date	<b>Emissione corrente</b> Current issue	<b>Data di scadenza</b> Expiring date	<b>ICIM S.p.A.</b> Il Presidente Ing. Tullio Badino
12/03/2010	12/03/2010	11/03/2020	



# HOT-CIL emergency handle

Emergency handle for internal locks - EN 179:2008

**NINZ**<sup>®</sup>  
FIREDOORS

## HOT-CIL IN BLACK PLASTIC

### Description

Lever handle and fixed doorknob for emergency exits, especially for hotel rooms:

- Reversible for right or left opening
- Normally applied on single leaf doors or the active leaf of two-leaved doors if the inactive leaf normally remains closed and can only be opened manually with the latch bolt (019)
- Suitable for Rever/Univer/Proget doors and other types of emergency exit pull doors
- The lever, doorknob and even the cover plates are made of black plastic, while the core of the lever and the installation plates are made of galvanized steel
- The lock is anti-panic/fire rated pull type for Euro profile cylinders
- Mastered cylinder to pass with thumbturn latch on the pull side made of nickel-plated brass with 3 keys
- Suitable for doors with dimensions up to 1350 x 2880mm/leaf, mass up to 300kg/leaf, with fire rating EI,120 - REI120 and smoke resistance, handle protrusion of 67mm

### Use

The HOT-CIL emergency exit handle is to be applied on doors designated for emergency situations in which the people involved are accustomed to using safety exits and their opening devices, and who are therefore very unlikely to be in a state of panic.

### Operating mode

The door can be opened from the push side by key only, while it can be opened at any time from the pull side by pressing the handle, even when the lock is locked using the key. The lock has two bolts that protrude when the key or the thumbturn latch is turned.

## VERSIONS AVAILABLE

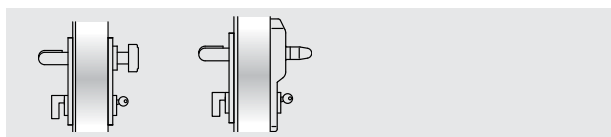

HOT-CIL

HOT-CIL ELM/mt

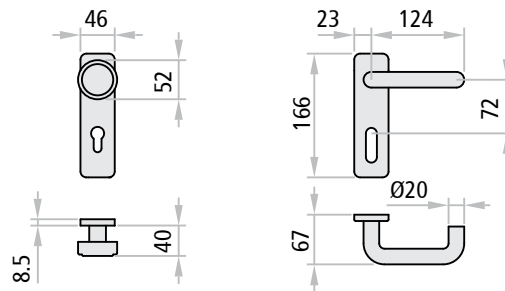

## SUPPLIED TOGETHER WITH THE DOOR

**For the single leaf or active leaf of two-leaved doors (the inactive leaf normally remains closed and can only be opened manually using the bolt lock (019)):**

*Included (mounted on the door):* the anti-panic lock with 65mm entrance and the strike box insert.

*Included (in the package):* Nr. 1 lever handle and Nr. 1 fixed doorknob in black plastic, Nr. 2 galvanized steel installation plates, Nr. 2 black plastic cover plates, Nr. 1 square spindle, Nr. 1 mastered cylinder with thumbturn latch on the pull side made of nickel-plated brass with 3 keys, fastener screws, Nr. 1 adhesive pictogram (green arrow), Nr. 1 set of instructions for installation/maintenance.

*Versions available:* HOT-CIL, HOT-CIL ELM/mt.

*ELM electric handle:* see the dedicated pages.

## HOT-CIL KIT VERSION

### (SUPPLIED SEPARATELY FROM THE DOOR)

**KIT for single leaf or the active leaf of two-leaved doors (the inactive leaf normally remains closed) and can only be opened manually using the bolt lock (019):**

Specify the leaf thickness in the order.

*KIT contents:* Nr. 1 anti-panic lock with 65mm entrance, Nr. 1 strike box insert, Nr. 1 lever handle and Nr. 1 fixed doorknob in black plastic, Nr. 2 galvanized steel installation plates, Nr. 2 black plastic cover plates, Nr. 1 square spindle, Nr. 1 mastered cylinder with thumbturn latch on the pull side made of nickel-plated brass with 3 keys, fastener screws, Nr. 1 adhesive pictogram (green arrow), Nr. 1 set of instructions for installation/maintenance.

*Versions available:* HOT-CIL

REVER  
multipurpose

# HOT-CIL-X emergency handle

Emergency handle for internal locks - EN 179:2008

**NINZ**<sup>®</sup>  
FIREDOORS

## HOT-CIL-X IN STAINLESS STEEL

### Description

Lever handle and fixed doorknob for emergency exits, especially for hotel rooms:

- Lever handle and fixed doorknob for emergency exits, especially for hotel rooms:
- Reversible for right or left opening
- Normally applied on single leaf doors or the active leaf of two-leaved doors if the inactive leaf normally remains closed and can only be opened manually with the latch bolt (019)
- Suitable for Rever/Univer/Proget doors and other types of emergency exit pull doors
- The lever, doorknob and cover plates are made of AISI 304 brushed stainless steel, while the installation plates are made of galvanized steel
- The lock is anti-panic/fire rated for Euro profile cylinders
- Mastered cylinder to pass with thumbturn latch on the pull side made of nickel-plated brass with 3 keys
- Suitable for doors with dimensions up to 1350x2880mm/leaf, mass up to 300kg/leaf, fire rated to EI<sup>2</sup>120 - REI120 and smoke resistance, handle protrusion of 67mm

### Use

The HOT-CIL-X emergency exit handle is for use on doors designated for emergency situations in which the people involved are accustomed to using safety exits and their opening devices, and who are therefore very unlikely to be in a state of panic.

### Operating mode

The door can be opened from the push side by key only, while it can be opened at any time from the pull side by pressing the handle, even when the lock is locked using the key. The lock has two bolts that protrude when the key or the thumbturn latch is turned.

## VERSIONS AVAILABLE

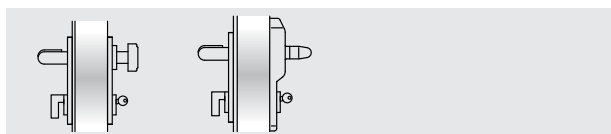

HOT-CIL-X

HOT-CIL-X ELM/mt

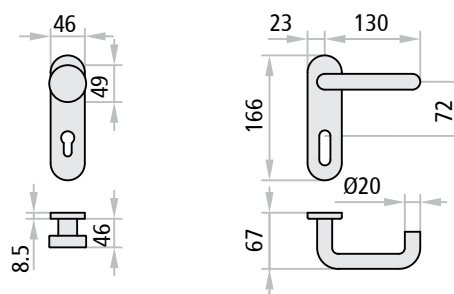

## SUPPLIED TOGETHER WITH THE DOOR

**For the single leaf or active leaf of two-leaved doors (the inactive leaf normally remains closed and can only be opened manually using the bolt lock (019)):**

*Included (mounted on the door):* the anti-panic lock with 65mm entrance and the strike plate insert.

*Included (in the package):* Nr. 1 lever handle and Nr. 1 fixed doorknob in brushed stainless steel, Nr. 2 galvanized steel installation plates, Nr. 2 cover plates in brushed stainless steel, Nr. 1 square spindle, Nr. 1 mastered cylinder with thumbturn latch on the pull side made of nickel-plated brass with 3 keys, fastener screws, Nr. 1 adhesive pictogram (green arrow), Nr. 1 set of instructions for installation/maintenance.

*Versions available:* HOT-CIL-X, HOT-CIL-X ELM/mt. ELM electric handle: see the dedicated pages.

## HOT-CIL-X KIT VERSION

**(SUPPLIED SEPARATELY FROM THE DOOR)**

**KIT for single leaf or the active leaf of two-leaved doors (the inactive leaf normally remains closed and can only be opened manually using the bolt lock (019)):**

Specify the leaf thickness in the order.

*KIT contents:* Nr. 1 anti-panic lock with 65mm entrance, Nr. 1 strike plate insert, Nr. 1 lever handle and Nr. 1 fixed doorknob in brushed stainless steel, Nr. 2 galvanized steel installation plates, Nr. 2 cover plates in brushed stainless steel, Nr. 1 square spindle, Nr. 1 mastered cylinder with thumbturn latch on the pull side made of nickel-plated brass with 3 keys, fastener screws, Nr. 1 adhesive pictogram (green arrow), Nr. 1 set of instructions for installation/maintenance.

*Versions available:* HOT-CIL-X

# Certifications

Emergency handle for internal locks - EN 179:2008



## HOT-CIL, HOT-CIL-X CERTIFICATION

Suitable for one-leaved doors or two-leaved doors with the second leaf semi-fixed and not equipped with emergency or anti-panic devices, with dimensions up to 1350x2880mm/leaf, mass up to 300kg/leaf.



Denomination	HOT-CIL, HOT-CIL-X EMERGENCY EXIT DEVICE
Manufacturer	Ninz S.p.A. Corso Trento, 2/A I-38061 ALA (TN)/ITALY
Year application trademark	10
Nr. and year of the standard	EN 179:2008
Certifying body	0425
CE certificate Nr.	0425-CPR-2149
Classification	<b>3 7 7 B 1 4 4 2 A D</b>

- 1st Category of use very frequent
- 2nd Durability 200.000 cycles
- 3rd Door mass over 200 kg
- 4th Suitable for fire/smoke rated doors
- 5th Safety, suitable for evacuation routes
- 6th High corrosion resistance 240 h
- 7th Material safety 1000 N
- 8th Handle protrusion up to 100 mm
- 9th Activation type with lever handle
- 10th Suited for one-leaved doors, pull opening

**Certificato di costanza delle prestazioni**  
*Certificate of constancy of performance*

ALLEGATO A1 / ANNEX TO

Certificato N. **0425 - CPR - 2149**  
Certificate No.

In conformità al Regolamento 305/2011/UE del Parlamento Europeo e del Consiglio del 9 marzo 2011 (Regolamento Prodotti da Costruzione o CPR), questo certificato si applica al prodotto da costruzione.  
In compliance with Regulation 305/2011/UE of the European Parliament and of the Council of 9 March 2011 (the Construction Products Certification or CPR), this certificate applies to the construction product.

<b>MODELLI</b> MODELS	<b>Modelli / Models</b> HOT-CIL, HOT-CIL-X  <b>Serratura anta attiva / Active leaf lock</b> art. 3201001.011 (AP sp ti),  Contropiastre / striking plates. 2401006, 2401005, 2401015, 2401014,  Maniglia / Handles art. 3101001.012 (M2), 3101017.002 (M2X)
<b>CLASSIFICAZIONE</b> CLASSIFICATION	<b>3 7 7 B 1 4 4 2 A D</b>
<b>MODELLI</b> MODELS	<b>Modelli / Models</b> M3 TIR, M3X TIR <b>Serratura anta attiva / Active leaf lock</b> art. 3201001.051 (016 tir REV), 3201001.049 (MAC3 sx), 3201001.050 (MAC3 dx).  Contropiastre / striking plates. 2401006, 2401005, 2401015, 2401014, 3201001.023, 3201001.007  Maniglia / Handles art. 3101001.009 (M3), 3101017.003 (M3X)
<b>CLASSIFICAZIONE</b> CLASSIFICATION	<b>3 7 7 B 1 3 4 2 A D</b>
<b>SISTEMA DI VALUTAZIONE E VERIFICA DELLA COSTANZA DELLA PRESTAZIONE</b> SYSTEM OF ASSESSMENT AND VERIFICATION OF CONSTANCY OF PERFORMANCE	
<b>1</b>	

**ICIM S.p.A.**  
EMMISSIONE  
ISSUE:  
05/06/2014  
ICIM S.p.A. è socio unico - Piazza Don Enrico Mappelli, 15 - 20090 Sesto San Giovanni (MI)

Annex Page 1/5

REVER multipurpose

# M14 emergency handle

Emergency handle for insertion in lock - EN 179:2008

## M14 IN BLACK PLASTIC

### Description

Lever handle for emergency exit:

- Reversible for right or left opening
- For application to the inactive leaf of two-leaved doors located at emergency exits
- Suitable for Rever/Univer/Proget doors and other types of emergency exit doors
- The lever and cover plate are both made of black plastic, while the core of the lever and the installation plate are made of galvanized steel (with external installation plate in case of Rever door)
- The safety lock is anti-panic fire rated, activates the vertical rods and ensures automatic closure
- Suitable for doors with dimensions up to 1350x 2880mm/leaf, mass up to 300kg/leaf, with fire rating EI<sub>2</sub>120 - REI120 and smoke resistance, handle protrusion of 67mm

### Use

The M14 emergency exit handle is to be applied to doors designated for emergency situations in which the people involved are accustomed to using safety exits and their opening devices, and who are therefore highly unlikely to be in a state of panic.

The active (main) leaf must also be equipped with an anti-panic or emergency device.

### Operating mode

The M14 emergency device is always used in combination with a second device for safety or emergency exits that is applied to the active (main) leaf, and for this reason does not include external opening door furnitures.

From the push side, opening is possible at any time by pushing on the handle, which causes the vertical rods to retract and at the same time pulls back the bolt of the active leaf's lock, unlatching both doors.

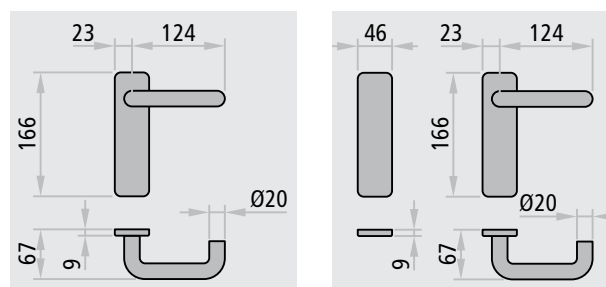

version for Univer/Proget door

version for Rever door

## SUPPLIED TOGETHER WITH THE DOOR

### For the inactive leaf of two-leaved doors:

*Included (mounted on the door):* anti-panic safety lock with 80mm entrance, vertical rods, upper locking device, upper strike plate.

*Included (in the package):* Nr. 1 black plastic lever handle with galvanized steel installation plate and blank black plastic cover plate (with external installation plate for Rever doors), Nr. 1 square spindle, Nr. 1 floor-mounted floor catch, Nr. 1 carrier arm (for fire doors only), fastener screws, Nr. 1 adhesive pictogram (green arrow), Nr. 1 set of instructions for installation/maintenance.

## M14 KIT VERSION (SUPPLIED SEPARATELY FROM THE DOOR)

### KIT for the inactive leaf of two-leaved doors:

Please specify the door type - REVER, UNIVER or PROGET - in the order.

*KIT contents:* Nr. 1 anti-panic safety lock with 80mm entrance, Nr. 1 black plastic lever handle with galvanized steel installation plate and blank black plastic cover plate (with external installation plate for Rever doors), Nr. 1 square spindle, Nr. 1 upper locking device (for Rever and Univer multipurpose only), Nr. 1 carrier arm (excluding Rever and Univer multipurpose doors), fastener screws, Nr. 1 adhesive pictogram (green arrow), Nr. 1 set of instructions for installation/maintenance.

# M14X emergency handle

Emergency handle for internal locks - EN 179:2008



## M14X IN STAINLESS STEEL

### Description

Lever handle for emergency exit:

- Reversible for right or left opening
- For application to the inactive leaf of two-leaved doors located at emergency exits
- Suitable for Rever/Univer/Proget doors and other types of emergency exit doors
- The lever and cover plate are both made of AISI 304 brushed stainless steel, while the installation plate is made of galvanized steel (with external installation plate in case of Rever door)
- The safety lock is anti-panic/fire rated, activates the vertical rods and ensures automatic closure
- Suitable for doors with dimensions up to 1350x2880mm/leaf, mass up to 300kg/leaf, with fire rating EI<sub>2</sub>120 - REI120 and smoke resistance, handle protrusion of 67mm

### Use

The M14X emergency exit handle is to be applied on doors designated for emergency situations in which the people involved are accustomed to using safety exits and their opening devices, and who are therefore highly unlikely to be in a state of panic.

The active (main) leaf must also be equipped with an anti-panic or emergency device.

### Operating mode

The M14X emergency device is always used in combination with a second device for safety or emergency exits that is applied to the active leaf, and for this reason does not include external opening door furnishings.

From the push side, opening is possible at any time by pushing on the handle, which causes the vertical rods to retract and at the same time pulls back the bolt of the active leaf's lock, unlatching both doors.

## M14, M14X CERTIFICATION

Suited for the inactive leaf of two-leaved doors with dimensions up to 1350x2880mm/leaf, mass up to 300kg/leaf.

<b>Denomination</b>	M14, M14X EMERGENCY EXIT DEVICE
<b>Manufacturer</b>	Ninz S.p.A. Corso Trento, 2/A I-38061 ALA (TN)/ITALY
<b>Year application trademark</b>	10
<b>Nr. and year of the standard</b>	EN 179:2008
<b>Certifying body</b>	0425
<b>CE certificate Nr.</b>	2148-CPD-2010
<b>Classification</b>	<b>3 7 7 B 1 4 4 2 A C</b>

- 1st Category of use very frequent
- 2nd Durability 200.000 cycles
- 3rd Door mass over 200 kg
- 4th Suitable for fire/smoke rated doors
- 5th Safety, suitable for evacuation routes
- 6th High corrosion resistance 240 h
- 7th Material safety 1000 N
- 8th Handle protrusion up to 100 mm
- 9th Activation type with lever handle
- 10th Suited for door: two-leaved, on the inactive leaf only

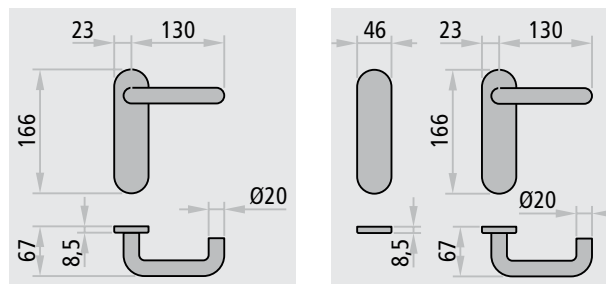

version for Univer/Proget door

version for Rever door

## SUPPLIED TOGETHER WITH THE DOOR

### For the inactive leaf of two-leaved doors:

*Included (mounted on the door):* anti-panic safety lock with 80mm entrance, vertical rods, upper locking device, upper strike plate.

*Included (in the package):* Nr. 1 lever handle in brushed stainless steel with galvanized steel installation plate and blank cover plate in brushed stainless steel (with external installation plate for Rever doors), Nr. 1 square spindle, Nr. 1 floor-mounted door catch, Nr. 1 carrier arm (for fire doors only), fastener screws, Nr. 1 adhesive pictogram (green arrow), Nr. 1 set of instructions for installation/maintenance.

## M14X KIT VERSION (SUPPLIED SEPARATELY FROM THE DOOR)

### KIT for the inactive leaf of two-leaved doors:

Please specify the door type - REVER, UNIVER or PROGET - in the order.

*KIT contents:* Nr. 1 anti-panic safety lock with 80mm entrance, Nr. 1 lever handle in brushed stainless steel with galvanized steel installation plate and blank cover plate in brushed stainless steel (with external installation plate for Rever doors), Nr. 1 square spindle, Nr. 1 upper locking device (for Rever and Univer multipurpose only), Nr. 1 carrier arm (excluding Rever and Univer multipurpose doors), fastener screws, Nr. 1 adhesive pictogram (green arrow), Nr. 1 set of instructions for installation/maintenance.

ATTESTATO DI CONFORMITÀ DIRETTIVA 89/106/CEE CERTIFICATE OF CONFORMITY DIRETTIVE 89/106/CEE		CE 0425
Questo certificato è rilasciato in conformità a quanto prescritto dall'Art.6 par.2 lettera b) del DPR 21 aprile 1993, n° 246 (Direttiva 89/106/CEE) ed attesta la conformità del prodotto di seguito identificato agli Art.1, Art.2 ed allegato A del DPR 21 aprile 1993, n° 246 (Direttiva 89/106/CEE)		
This certificate is issued in accordance with the requirements defined in Article 6 par 2 lett. B) of DPR 21th April 1993, n° 246 (89/106/CE Directive) and certifies the compliance of the product to art. 1, art. 2 and annex A of DPR 21th April 1993, n° 246 (89/106/CE Directive)		
<b>ATTESTATO N°</b>	<b>2148 - CPD - 2010</b>	<b>CERTIFICATE N°</b>
<b>Organismo notificato</b>	ICIM S.p.A. - Piazza Don Mapelli, 75 - 20099 SESTO SAN GIOVANNI	<b>Notified Body</b>
<b>Dati Fabbricante</b>	Sede legale: NINZ S.p.A. Corso Trento, 2/A 38061 ALA (TN) ITALY Unità operativa:	<b>Manufacturer details</b> Head office Production unit
<b>Dati prodotto</b>	Tipologia: DISPOSITIVI PER USCITE DI EMERGENZA AZIONATI MEDIANTE MANIGLIA A LEVA O PIASTRA A SPINTA EMERGENCY EXIT DEVICES OPERATED BY A LEVER HANDLE OR PUSH PAD Denominazione: Dispositivo di emergenza serie "M14" "M14X" Controserrature antipanico art. AP020P, AP020U, 3201001.006 Dispositivo superiore art. 3105080, 3105024, 3305003 Riscontro asta art. 2401046, 2401044, 2401002 Boccola pavimento art. 2401001, 2401007, 3105091, 2401020 Aste verticali art. 3305015, 3305016, 3305002, 3305005 Comandi art. 3101001.008 (M14), 3101017.004 (M14X)	<b>Product details</b> Type Denomination
Sistema di attestazione della conformità: 1 System of attestation of conformity		
Norma di riferimento: EN 179:2008 Standard reference		
Classificazione:   3   7   7   B   1   4   4   2   A   C   Classification		
<b>Eventuali estensioni</b>	Nessuna / None	<b>Extensions</b>
<b>Eventuali condizioni di subordinazione della Certificazione CE</b>	Nessuna / None	<b>Condition of subordination of CE certification</b>
Il presente attestato è valido esclusivamente per il prodotto indicato. Eventuali varianti da apportare devono essere approvate da ICIM SpA The present certificate is valid only for the product described above. Every change has to be approved by ICIM S.p.A.		
<b>Data di emissione</b> Issue date	<b>Emissione corrente</b> Current issue	<b>Data di scadenza</b> Expiring date
12/03/2010	28/04/2010	11/03/2020
		 ICIM S.p.A. Il Presidente Ing. Tullio Badino

REVER multipurpose

# EXUS<sup>®</sup>

REVER  
multipurpose



## PRESENTATION

### EXUS® panic bars

Ninz S.p.A. is a leader in fire doors, and has once again reasserted itself as a visionary company with a strong identity created by its continuous research into the design and technology of its own products, such as the new line of EXUS® panic bars.

The EXUS® panic bars are CE marked and according to European standard EN 1125:2008, which entered in effect January 01, 2010, and which prescribes a series of substantial changes that further extend the requirements for maximum safety and ease of opening.

### The KIT designed for your needs

When ordered separately from the door, the EXUS® series of panic bars is provided in elegant and functional KITS packaged for presentation in the most appropriate format for distribution.

Packaging in KITS ensures customers, installers and therefore the final users that they are receiving a complete anti-panic system with fully corresponding parts which are all CE certified.

### Finishing

Attention to detail and proportions are highlighted by select materials and finishing.

In addition to the **black PLASTIC** version combined with **anodized ALUMINUM** bars, new combinations include the all **brushed STAINLESS STEEL** version and the **polished chromed ALUMINUM** version combined with the **anodized ALUMINUM** bar. Many other color and surface combinations are possible for equally aesthetic solutions. The particular aesthetics of soft forms is one of the exclusive advantages of **EXUS® panic bars**, representing the fruit of designs generated in collaboration with Studio MM Design, which has been working with the company for many years.

### Certifications and replacements

Given the importance of maintaining the entire system's CE conformity, special attention has been paid to replacement parts, which have been subjected to testing in accordance with the EN 1125:2008 standard due to their pivotal role in maintaining CE certification.

The only way to ensure that the products maintain their original characteristics over time is by using **original NINZ replacement parts**.

For this reason, the instructions for **EXUS® panic bars** include additional indications regarding proper installation and maintenance plus an exploded assembly drawing that specifies every smallest detail of the certified system with all of the references required for ordering replacement parts.

With the new EXUS® panic bar, NINZ S.p.A. demonstrates its willingness to believe in market development by investing in designs and company image in order to endow its own products with added value while maintaining highly competitive quality-price ratios.



Black PLASTIC handle



Brushed STAINLESS STEEL handle

### NOTE

By default external door furniture is provided with the same finishing as the panic bar.

# EXUS® - Features, certifications

Panic bar



REVER  
multipurpose

## FEATURES

- Newly designed product with state of the art technological concept
- Available several in color and surface combinations: brushed stainless steel for the lever arms and the bar, or aluminum with polished chrome lever arms and anodized aluminum bar, and finally the classic ever-green combination - black plastic lever arms with anodized aluminum bar
- Certified for internal lock with 40 or 65mm entrances for single leaves or active leaves, with 30 or 80mm entrance for inactive leaves and with square spindle rotation of up to 45°
- Possibility of locking by key on the bar side as well
- Reversible for Right or Left mounting
- Protrusion 125mm
- Proposed together with the door or separately in a complete KIT packaged in a black/yellow box
- Label applied to the packaging to identify the product's characteristics
- Wide range of customizations: colored bar, colored or stainless steel handles, lock with access control mechanisms, special coded or mastered cylinders

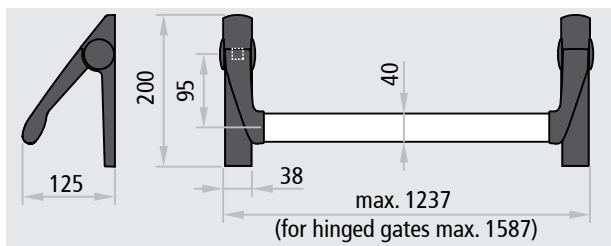

## CERTIFICATION

Suited for one-leaved doors or the active and inactive leaves of two-leaved doors with dimensions up to 1350x2880mm/leaf, mass up to 300kg/leaf.

<b>CE</b>	
<b>Denomination</b>	EXUS PANIC BAR
<b>Manufacturer</b>	Ninz S.p.A. Corso Trento, 2/A I-38061 ALA (TN)/ITALY
<b>Year application trademark</b>	08
<b>Nr. and year of the standard</b>	EN 1125:2008
<b>Certifying body</b>	0425
<b>CE certificate Nr.</b>	0425 CPD 1228
<b>Classification</b>	<b>3 7 7 B 1 3 2 1 A A</b>

- 1st Category of use very frequent
- 2nd Durability 200.000 cycles
- 3rd Door mass over 200 kg
- 4th Suitable for fire/smoke rated doors
- 5th Safety, suitable for evacuation routes
- 6th High corrosion resistance 96 h
- 7th Material safety 1000 N
- 8th Bar protrusion up to 150 mm
- 9th Activation type with push bar
- 10th Suited for one- or two-leaved doors



EXUS® is a registered trademark owned by Ninz S.p.A.

Also suited for doors with fire ratings:



ATTESTATO N°		0425 CPD 1228		CERTIFICATE N°	
Organismo notificato			Notified Body		
ICIM S.p.A. - Piazza Don Mapelli, 75 - 20099 Sesto San Giovanni (MI) ITALY			Identification number: 0425		
Dati Fabbricante			Manufacturer		
Sede legale			Head office		
Unità operativa			Operative unit		
Dati prodotto			Product		
Tipologia		DISPOSITIVI ANTIPANICO PER USCITE DI SICUREZZA AZIONATI MEDIANTE UNA BARRA ORIZZONTALE		Type	
Denominazione		PANIC EXIT DEVICES		Denomination	
Dispositivo antipatico		serie "TWIST" "EXUS LP" "EXUS LA" "EXUS LX"			
Serrature antipatico		art. AP16/18, SCA 1 3201001.019020, MAC 1 3201001.041042, 4506002.17 (V), 3201001.018, 485-85-0, 4506002.22 (V), B18310-02-RL-8 (V), B18370-04-U-8 (V)			
Controserrature antipatico		art. AP020P, AP020U, 4506002.18 (V), 3201001.6, 43190.95, B1890.1004 (V)			
Dispositivo superiore		art. 3105080, 3105024, 4506003 (V), 3305003, B1795.0001 (V), B1895.0003 (V)			
Riscontro asta		art. 2401036, 2401046, 2401044, 4506005 (V), 2401002, B9000.0567 (V), B9000.0490 (V)			
Boccola pavimento		art. 2401001, 2401007, 3106091, 4509006 (V), 2401020, 4419008, B9028.0001 (V)			
Deviatori		art. 4201010			
Aste verticali		art. 3305015, 3305016, 3305002, 4509003 (V), 3305013, 990837, B9006.0014 (V), B9006.0005 (V)			
Riscontro serratura		art. 2401006, 2401005, 2401015, 2401014, 4506006 (V), 2401005, 2401035, 3412001, B9000.0402 (V)			
Comandi esterni		art. BM, BSP, BS, BMC, BC, B, A, BM inox, BM alu, BSP inox, BSP alu			
Sistema di attestazione della conformità			1		
Norma di riferimento			EN1125:2008		
Classificazione			3   7   7   B   1   3   2   1   A   A		
Eventuali estensioni			Nessuna / None		
Eventuali condizioni di subordinazione della Certificazione CE			Nessuna / None		
Il presente attestato è valido esclusivamente per il prodotto indicato. Eventuali varianti da apportare devono essere approvate da ICIM S.p.A.			Possible conditions of subordination of the CE Certification		
Data di emissione / First issue			Emissione corrente / Current issue		
Data di scadenza / Expiring date			ICIM S.p.A.		
18/04/2007			26/06/2013		
			17/04/2017		



## EXUS® LP IN BLACK PLASTIC

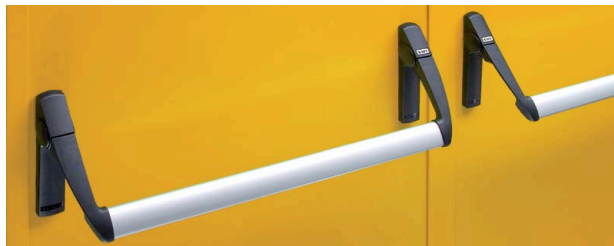

### Description

The EXUS LP panic bar consists of an anodized aluminum horizontal bar that inserts into the lever arms attached to the mechanisms which activate the lock.

- Reversible for right or left opening
- For application to single leaf and two-leaved doors
- Suited for Rever/Univer/Proget doors and other types of panic exit doors
- The horizontal bar is made of extruded anodized aluminum with an elliptical cross-section measuring 40x20mm and a length of 1150mm
- Two black plastic lever arms with galvanized steel core
- The two mechanisms are made of galvanized steel with black plastic carter covers, one of which has an EXIT label that identifies the lock side
- The lock is anti-panic/fire rated for Euro profile cylinders
- The door furnitures and related cover plates are made of black plastic, while the installation plate is made of galvanized steel
- DC version with cylinder to pass

### VERSIONS AVAILABLE

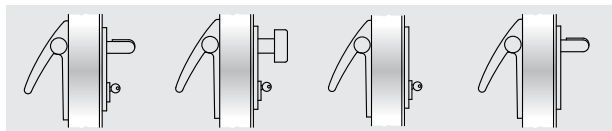

BM

BSP

BS

BMC

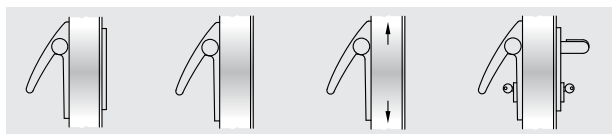

BC

B

A

DC BM

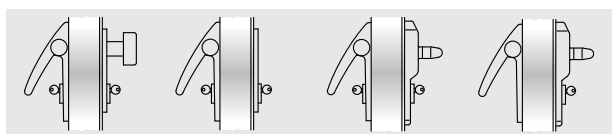

DC BSP

DC BS

DC ELM

ELM

### VARIATIONS ON REQUEST (see dedicated page)

- Aluminum bar painted in RAL colors
- External BM, BSP, BS, BMC and BC door furnitures in brushed stainless steel
- External BM and BSP door furnitures painted in RAL colors
- MAC1 panic lock with access control system, combinable with the BM and DC BM versions
- Mastered or coded cylinders
- Microswitch and cable sleeve for signaling when the door is open

## EXUS LP (SUPPLIED WITH THE DOOR)

### For single leaf or the active leaf of two-leaved doors:

*Included (mounted on the door):* the anti-panic lock with 65mm entrance and the strike box lock insert

*Included (in the package):* Nr. 2 mechanisms, Nr. 2 black plastic carter covers, Nr. 2 black plastic lever arms, Nr. 1 anodized aluminum bar, Nr. 1 black plastic external door furniture, Nr. 1 half-cylinder with 3 keys, Nr. 1 cylinder to pass with 3 keys (DC version only), Nr. 1 drilling template, Nr. 1 adhesive pictogram (green arrow), Nr. 1 set of installation/maintenance instructions

*Versions available:* BM, BSP, BS, BMC, BC, B (for Proget doors only), DC BM, DC BSP, DC BS, DC ELM, ELM

ELM electric handle: see the dedicated pages

### For the inactive leaf of two-leaved doors:

*Included (mounted on the door):* anti-panic safety lock with 80mm entrance, the upper re-latch device, the upper strike plate and the vertical rods

*Included (in the package):* Nr. 2 mechanisms, Nr. 2 black plastic carter covers, Nr. 2 black plastic lever arms, Nr. 1 anodized aluminum bar, Nr. 1 floor-mounted floor catch, Nr. 1 carrier arm (for fire doors only), Nr. 1 drilling template, Nr. 1 adhesive pictogram (green arrow), Nr. 1 set of installation/maintenance instructions

*Versions available:* A

## EXUS LP KIT

### (SUPPLIED SEPARATELY FROM THE DOOR)

#### KIT for single leaf or the active leaf of two-leaved doors:

Please specify leaf thickness and door type - REVER, UNIVER or PROGET - in the order

*KIT contents:* Nr. 1 anti-panic lock with 65mm entrance, Nr. 1 strike box lock insert, Nr. 2 mechanisms, Nr. 2 black plastic carter covers, Nr. 2 black plastic lever arms, Nr. 1 anodized aluminum bar, Nr. 1 black plastic external door furniture, Nr. 1 half-cylinder with 3 keys, Nr. 1 cylinder to pass with 3 keys (DC version only), Nr. 1 drilling template, Nr. 1 adhesive pictogram (green arrow), Nr. 1 set of installation/maintenance instructions

*Versions available:* BM, BSP, BS, BMC, DC BM, DC BSP, DC BS

#### KIT for the inactive leaf of two-leaved doors, suited for REVER, UNIVER and PROGET fire and multipurpose doors (produced after 01.01.2005):

specify door type on the order form

*KIT contents:* Nr. 1 anti-panic safety lock with 80mm entrance, Nr. 2 mechanisms, Nr. 2 black plastic carter covers, Nr. 2 black plastic lever arms, Nr. 1 anodized aluminum bar, Nr. 1 upper re-latch device, Nr. 1 floor-mounted floor catch, Nr. 1 carrier arm (excluding REVER and UNIVER MULTIPURPOSE), Nr. 1 drilling template, Nr. 1 adhesive pictogram (green arrow), Nr. 1 set of installation/maintenance instructions

*Versions available:* A

#### KIT for the inactive leaf of two-leaved doors and suited for other types of multipurpose doors and for substitution of non CE marked panic bars (PROGET doors):

*KIT contents:* Nr. 1 anti-panic safety lock with 80mm entrance, Nr. 2 mechanisms, Nr. 2 black plastic carter covers, Nr. 2 black plastic lever arms, Nr. 1 anodized aluminum bar, Nr. 1 upper re-latch device, Nr. 1 upper strike plate, vertical rods, Nr. 1 floor-mounted floor catch, Nr. 1 carrier arm, Nr. 1 drilling template, Nr. 1 adhesive pictogram (green arrow), Nr. 1 set of installation/maintenance instructions

*Versions available:* A

**EXUS® LA IN ALUMINUM**

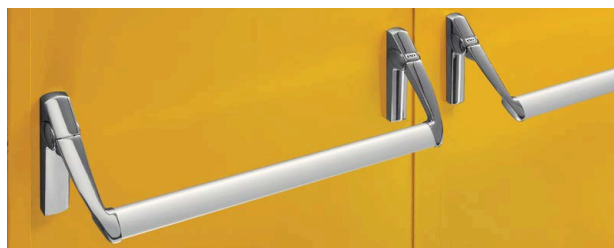

**Description**

The EXUS LA panic bar consists of an anodized aluminum horizontal bar that inserts into lever arms attached to the mechanisms which activate the lock.

- Reversible for right or left opening
- For application to single leaf and two-leaved doors
- Suited for Rever/Univer/Proget doors and other types of panic exit doors
- The horizontal bar is made of extruded anodized aluminum with an elliptical cross-section measuring 40x20mm and a length of 1150mm
- The two lever arms are made of an aluminum alloy with a polished chrome finish
- The two mechanisms are made of galvanized steel with aluminum alloy carter covers with a polished chrome finish, one of which has an EXIT label to identify the lock side
- The lock is anti-panic/fire rated for Euro profile cylinders
- The door furnishings and related cover plates are made of AISI 304 brushed stainless steel, while the installation plate is made of galvanized steel
- The arms and carter covers are finished with tri-valent chrome in compliance with the ROHS regulation
- DC version with cylinder to pass

**VERSIONS AVAILABLE**

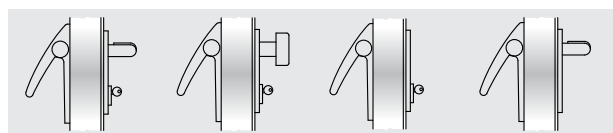

BM BSP BS BMC

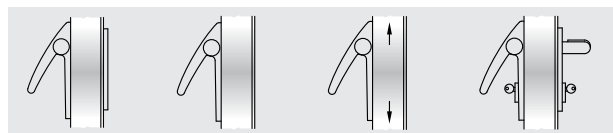

BC B A DC BM

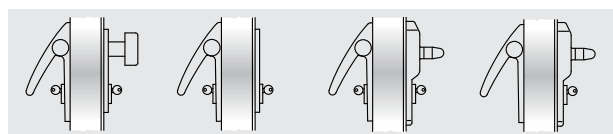

DC BSP DC BS DC ELM ELM

**VARIATIONS ON REQUEST** (see dedicated page)

- Aluminum bar painted in RAL colors
- MAC1 panic lock with access control system, combinable with the BM and DC BM versions
- Mastered or coded cylinders
- Microswitch and cable sleeve for signaling when the door is open

**EXUS LA (SUPPLIED WITH THE DOOR)**

**For single leaf or the active leaf of two-leaved doors:**

*Included (mounted on the door):* the anti-panic lock with 65mm entrance and the strike box lock insert

*Included (in the package):* Nr. 2 mechanisms, Nr. 2 polished chrome aluminum carter covers, Nr. 2 polished chrome aluminum lever arms, Nr. 1 anodized aluminum bar, Nr. 1 stainless steel external door furniture, Nr. 1 half-cylinder with 3 keys, Nr. 1 cylinder to pass with 3 keys (DC version only), Nr. 1 drilling template, Nr. 1 adhesive pictogram (green arrow), Nr. 1 set of installation/maintenance instructions

*Versions available:* BM, BSP, BS, BMC, BC, B (for Proget doors only), DC BM, DC BSP, DC BS, DC ELM, ELM

ELM electric handle: see the dedicated pages

**For the inactive leaf of two-leaved doors:**

*Included (mounted on the door):* anti-panic safety lock with 80mm entrance, the upper re-latch device, the upper strike plate and the vertical rods

*Included (in the package):* Nr. 2 mechanisms, Nr. 2 polished chrome aluminum carter covers, Nr. 2 polished chrome aluminum lever arms, Nr. 1 anodized aluminum bar, Nr. 1 floor-mounted floor catch, Nr. 1 carrier arm (for fire doors only), Nr. 1 drilling template, Nr. 1 adhesive pictogram (green arrow), Nr. 1 set of installation/maintenance instructions

*Versions available:* A

**EXUS LA KIT**

**(SUPPLIED SEPARATELY FROM THE DOOR)**

**KIT for single leaf or the active leaf of two-leaved doors:**

Please specify leaf thickness and door type - REVER, UNIVER or PROGET - in the order

*KIT contents:* Nr. 1 anti-panic lock with 65mm entrance, Nr. 1 strike box lock insert, Nr. 2 mechanisms, Nr. 2 polished chrome aluminum carter covers, Nr. 2 polished chrome aluminum lever arms, Nr. 1 anodized aluminum bar, Nr. 1 stainless steel external door furniture, Nr. 1 half-cylinder with 3 keys, Nr. 1 cylinder to pass with 3 keys (DC version only), Nr. 1 drilling template, Nr. 1 adhesive pictogram (green arrow), Nr. 1 set of installation/maintenance instructions

*Versions available:* BM, BSP, BS, BMC, BC, DC BM, DC BSP, DC BS

**KIT for the inactive leaf of two-leaved doors, suited for REVER, UNIVER and PROGET fire and multipurpose doors (produced after 01.01.2005):** specify door type on the order form

*KIT contents:* Nr. 1 anti-panic safety lock with 80mm entrance, Nr. 2 mechanisms, Nr. 2 polished chrome aluminum carter covers, Nr. 2 polished chrome aluminum lever arms, Nr. 1 anodized aluminum bar, Nr. 1 upper re-latch device, Nr. 1 floor-mounted floor catch, Nr. 1 carrier arm (excluding REVER and UNIVER MULTIPURPOSE), Nr. 1 drilling template, Nr. 1 adhesive pictogram (green arrow), Nr. 1 set of installation/maintenance instructions

*Versions available:* A

**KIT for the inactive leaf of two-leaved doors and suited for other types of multipurpose doors and for substitution of non CE marked panic bars (PROGET doors):**

*KIT contents:* Nr. 1 anti-panic safety lock with 80mm entrance, Nr. 2 mechanisms, Nr. 2 polished chromed aluminum carter covers, Nr. 2 chromed aluminum lever arms, Nr. 1 anodized aluminum bar, Nr. 1 upper re-latch device, Nr. 1 upper strike plate, vertical rods, Nr. 1 floor-mounted floor catch, Nr. 1 carrier arm, Nr. 1 drilling template, Nr. 1 adhesive pictogram (green arrow), Nr. 1 set of installation/maintenance instructions

*Versions available:* A

**NOTE**

It is not advisable to use the anti-panic bar EXUS LA for marine environments or in particularly humid areas. For these situations the use of the anti-panic bar EXUS LX is recommended.

**EXUS® LX IN STAINLESS STEEL**



**Description**

The entire EXUS LX panic bar is made of stainless steel, and consists of a horizontal bar that inserts into lever arms attached to the mechanisms which activate the lock.

- Maximum corrosion resistance and noteworthy robustness of the entire set
- Optimal aesthetic appearance
- Reversible for right or left opening
- For application to single leaf and two-leaved doors
- Suited for Rever/Univer/Proget doors and other types of panic exit doors
- The horizontal bar is made of AISI 304 brushed stainless steel with an elliptical cross-section measuring 40x20mm, length of 1150mm
- The two lever arms are made of AISI 304 brushed stainless steel
- The two mechanisms are made of AISI 304 stainless steel
- The two carter covers are made of AISI 304 brushed stainless steel, and one is labeled with EXIT to identify the lock side
- The lock is anti-panic/fire rated for Euro profile cylinders
- The door furnitures and related cover plates are made of AISI 304 brushed stainless steel, while the installation plate is made of galvanized steel
- DC version with cylinder to pass

**VERSIONS AVAILABLE**

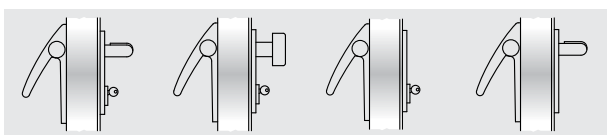

BM BSP BS BMC

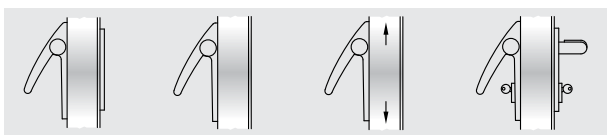

BC B A DC BM

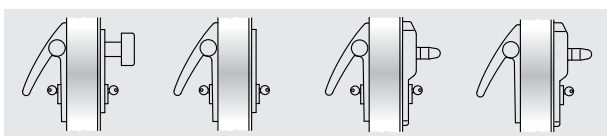

DC BSP DC BS DC ELM ELM

**VARIATIONS ON REQUEST** (see dedicated page)

- MAC1 panic lock with access control system, combinable with the BM and DC BM versions
- Mastered or coded cylinders
- Microswitch and cable sleeve for signaling when the door is open

**EXUS LX (SUPPLIED WITH THE DOOR)**

**For single leaf or the active leaf of two-leaved doors:**

*Included (mounted on the door):* the anti-panic lock with 65mm entrance and the strike box lock insert

*Included (in the package):* Nr. 2 stainless steel mechanisms, Nr. 2 stainless steel carter covers, Nr. 2 stainless steel lever arms, Nr. 1 stainless steel bar, Nr. 1 stainless steel external door furniture, Nr. 1 half-cylinder with 3 keys, Nr. 1 cylinder to pass with 3 keys (DC version only), Nr. 1 drilling template, Nr. 1 adhesive pictogram (green arrow), Nr. 1 set of installation/maintenance instructions

*Versions available:* BM, BSP, BS, BMC, BC, B (for Proget doors only), DC BM, DC BSP, DC BS, DC ELM, ELM

ELM electric handle: see the dedicated pages

**For the inactive leaf of two-leaved doors:**

*Included (mounted on the door):* anti-panic safety lock with 80mm entrance, the upper re-latch device, the upper strike plate and the vertical rods

*Included (in the package):* Nr. 2 stainless steel mechanisms, Nr. 2 stainless steel carter covers, Nr. 2 stainless steel lever arms, Nr. 1 stainless steel bar, Nr. 1 floor-mounted floor catch, Nr. 1 carrier arm (for fire doors only), Nr. 1 drilling template, Nr. 1 adhesive pictogram (green arrow), Nr. 1 set of installation/maintenance instructions

*Versions available:* A

**EXUS LX KIT**

**(SUPPLIED SEPARATELY FROM THE DOOR)**

**KIT for single leaf or the active leaf of two-leaved doors:**

Please specify leaf thickness and door type - REVER, UNIVER or PROGET - in the order

*KIT contents:* Nr. 1 anti-panic lock with 65mm entrance, Nr. 1 strike box lock insert, Nr. 2 stainless steel mechanisms, Nr. 2 stainless steel carter covers, Nr. 2 stainless steel lever arms, Nr. 1 stainless steel bar, Nr. 1 stainless steel external door furniture, Nr. 1 half-cylinder with 3 keys, Nr. 1 cylinder to pass with 3 keys (DC version only), Nr. 1 drilling template, Nr. 1 adhesive pictogram (green arrow), Nr. 1 set of installation/maintenance instructions

*Versions available:* BM, BSP, BS, BMC, BC, DC BM, DC BSP, DC BS

**KIT for the inactive leaf of two-leaved doors, suited for REVER, UNIVER and PROGET fire and multipurpose doors (produced after 01.01.2005):** specify door type on the order form

*KIT contents:* Nr. 1 anti-panic safety lock with 80mm entrance, Nr. 2 stainless steel mechanisms, Nr. 2 stainless steel carter covers, Nr. 2 stainless steel lever arms, Nr. 1 stainless steel bar, Nr. 1 upper re-latch device, Nr. 1 floor-mounted floor catch, Nr. 1 carrier arm (excluding REVER and UNIVER MULTIPURPOSE), Nr. 1 drilling template, Nr. 1 adhesive pictogram (green arrow), Nr. 1 set of installation/maintenance instructions

*Versions available:* A

**KIT for the inactive leaf of two-leaved doors and suited for other types of multipurpose doors and for substitution of non CE marked panic bars (PROGET doors):**

*KIT contents:* Nr. 1 anti-panic safety lock with 80mm entrance, Nr. 2 stainless steel mechanisms, Nr. 2 stainless steel carter covers, Nr. 2 stainless steel lever arms, Nr. 1 stainless steel bar, Nr. 1 upper re-latch device, Nr. 1 upper strike plate, vertical rods, Nr. 1 floor-mounted floor catch, Nr. 1 carrier arm, Nr. 1 drilling template, Nr. 1 adhesive pictogram (green arrow), Nr. 1 set of installation/maintenance instructions

*Versions available:* A

REVER  
multipurpose

# Twist

REVER  
multipurpose



## PRESENTATION

### TWIST panic bars

TWIST panic bars are **CE** marked in accordance with European standard EN 1125:2008, which entered in effect January 01, 2010, and which prescribes a series of substantial changes that further extend the requirements for maximum safety and ease of opening.

### The KIT designed for your needs

When ordered separately from the door, the **TWIST** series of panic bars is provided in elegant and functional KITS packaged for presentation in the most appropriate format for distribution.

Packaging in KITS ensures customers, installers and therefore the final users that they are receiving a complete anti-panic system with fully corresponding parts that are all **CE** certified.

### Finishing

The **TWIST** panic bar series is proposed in a **black PLASTIC** version combined with an **anodized ALUMINUM** bar. On request, the bar and the door furniture may be painted an RAL colors, opening up an infinite variety of aesthetic solutions.

### Certifications and replacements

Given the importance of maintaining the entire system's **CE** conformity, special attention has been paid to replacement parts, which have been subjected to testing in accordance with the EN 1125:2008 standard due to their pivotal role in maintaining **CE** certification.

The only way to ensure that the products maintain their original characteristics over time is by using **original NINZ replacement parts**.

For this reason, the instructions for **TWIST** panic bars include additional indications regarding proper installation and maintenance plus an explosion assembly drawing that specifies every smallest detail of the certified system with all of the references required for ordering replacement parts.

With the new packaging of the TWIST panic bar, NINZ S.p.A. demonstrates its intent to believe in market development by investing in designs and company image in order to endow its own products with added value while maintaining highly competitive quality-price ratios.



Black PLASTIC handle

### NOTE

The TWIST exit device series is combined with a black PLASTIC handle.

# TWIST - Features, certifications

Panic bar



## FEATURES

- The classic line of panic bars, an ever-green, available in the standard combination with black plastic arms/caps and anodized aluminum bar
- Certified for internal locks with a 65mm entrance for single leaves or active leaves, and with an 80mm entrance for inactive leaves
- Reversible for mounting on Right or Left doors
- Protrusion 100mm
- Proposed together with the door or separately in a complete KIT packaged in a single black/green box
- Packaging is labeled to identify product characteristics
- Wide range of customizations: colored bar, colored or stainless steel handles, locks with access control systems, special coded or mastered cylinders

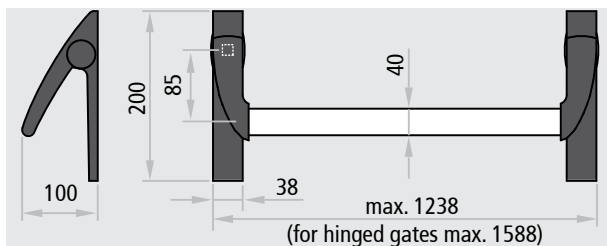

Also suited for doors with fire ratings:



## CERTIFICATION

Suited for one-leaved doors or the active and inactive leaves of two-leaved doors with dimensions up to 1350x2880mm/leaf, mass up to 300kg/leaf.

<b>CE</b>	
<b>Denomination</b>	TWIST PANIC BAR
<b>Manufacturer</b>	Ninz S.p.A. Corso Trento, 2/A I-38061 ALA (TN)/ITALY
<b>Year application trademark</b>	08
<b>Nr. and year of the standard</b>	EN 1125:2008
<b>Certifying body</b>	0425
<b>CE certificate Nr.</b>	0425 CPD 1228
<b>Classification</b>	<b>3 7 7 B 1 3 2 1 A A</b>

- 1st Category of use very frequent
- 2nd Durability 200.000 cycles
- 3rd Door mass over 200 kg
- 4th Suitable for fire/smoke rated doors
- 5th Safety, suitable for evacuation routes
- 6th High corrosion resistance 96 h
- 7th Material safety 1000 N
- 8th Bar protrusion up to 150 mm
- 9th Activation type with push bar
- 10th Suitable for one- or two-leaved doors

ATTESTATO DI CONFORMITÀ DIRETTIVA 89/106/CEE CERTIFICATE OF CONFORMITY DIRECTIVE 89/106/CEE		CE 0425
Questo certificato è rilasciato in conformità a quanto prescritto dall'Art.6 par.2 lettera b) del DPR 21 aprile 1993, n°246 (Direttiva 89/106/CEE) ed attesta la conformità del prodotto di seguito identificato agli Art.1, Art.2 ed allegato A del DPR 21 aprile 1993, n°246 (Direttiva 89/106/CEE). <i>This certificate has been issued in conformity to what prescribed by the Art.6 par.2 letter b) of the DPR 21/04/1993, n°246 (Directive 89/106/CEE) and certifies the conformity of the product described below to the Art.1, Art.2 and attachment A of DPR 21/04/1993, n°246 (Directive 89/106/CEE)</i>		
<b>ATTESTATO N°</b>	<b>0425 CPD 1228</b>	<b>CERTIFICATE N°</b>
<b>Organismo notificato</b>	ICIM S.p.A. - Piazza Don Mapelli, 75 - 20099 Sesto San Giovanni (MI) ITALY	<b>Notified Body</b>
<b>Dati Fabbricante</b>	Sede legale: NINZ S.p.A. Corso Trento, 2/A - 38061 ALA (TN) ITALY Unità operativa	<b>Manufacturer</b>
<b>Dati prodotto</b>	<b>DISPOSITIVI ANTIPANICO PER USCITE DI SICUREZZA AZIONATI MEDIANTE UNA BARRA ORIZZONTALE PANIC EXIT DEVICES</b>	<b>Product</b>
<b>Denominazione</b>	Dispositivo antipatico serie "TWIST" "EXUS LP" "EXUS LA" "EXUS LX". Serrature antipatico art. AP18/18, SCA 1 3201001.019/020, MAC 1 3201001.041/042, 4506002.17 (V), 3201001.018, 485-65-0, 4506002.22 (V), B18310-02-RL-8 (V), B18370-04-U-8 (V), Controserrature antipatico art. AP020P, AP020U, 4506002.18 (V), 3201001.6, 43190-95, B1890.1004 (V), Dispositivo superiore art. 3105080, 3105024, 4506003 (V), 3305003, B1795.0001 (V), B1895.0003 (V), Risccontro asta art. 2401036, 2401046, 2401044, 4506005 (V), 2401002, B9000.0567 (V), B9000.0490 (V), Boccola pavimento art. 2401001, 2401007, 3105091, 4506006 (V), 2401020, 4419008, B9028.0001 (V), Deviatori art. 4201010, Aste verticali art. 3305015, 3305016, 3305002, 4506003 (V), 3305013, 960837, B9006.0014 (V), B9006.0005 (V), Risccontro serratura art. 2401006, 2401005, 2401015, 2401014, 4506006 (V), 2401006, 2401035, 3412001, B9000.0402 (V), Comandi esterni art. BM, BSP, BS, BMC, BC, B, A, BM max, BM alu, BSP inox, BSP alu.	<b>Denomination</b>
<b>Sistema di attestazione della conformità</b>	1	<b>Attestation of conformity</b>
<b>Norma di riferimento</b>	EN 1125:2008	<b>Standard</b>
<b>Classificazione</b>	<b>3   7   7   B   1   3   2   1   A   A</b>	<b>Classification</b>
<b>Eventuali estensioni</b>	Nessuna / None	<b>Extensions</b>
<b>Eventuali condizioni di subordinazione della Certificazione CE</b>	Nessuna / None	<b>Possible conditions of subordination of the CE Certification</b>
Il presente attestato è valido esclusivamente per il prodotto indicato. Eventuali varianti da apportare devono essere approvate da ICIM SpA. <i>The present issue is valid only for the product described above. Possible changes to be brought in have to be approved by ICIM S.p.A.</i>		
<b>Data di emissione</b>	<b>Emissione corrente</b>	<b>Data di scadenza</b>
18/04/2007	26/06/2013	17/04/2017
		<b>ICIM S.p.A.</b>

## TWIST IN BLACK PLASTIC



### Description

The TWIST plastic panic bar consists of an anodized aluminum horizontal bar that inserts into the lever arms attached to the mechanisms used to activate the lock.

- Reversible for right or left opening
- For application to single leaf and two-leaved doors
- Suited for Rever/Univer/Proget doors and other types of panic exit doors
- The horizontal bar is made of extruded anodized aluminum with an elliptical cross-section measuring 40x20mm and a length of 1150mm
- Two black plastic lever arms with galvanized steel core
- The two mechanisms are made of galvanized steel with black plastic carter covers, one of which has an EXIT label that identifies the lock side
- The lock is anti-panic/fire resistance for Euro profile cylinders
- The door furnitures and the cover plates are made of black plastic, while the installation plate is made of galvanized steel

## VERSIONS AVAILABLE

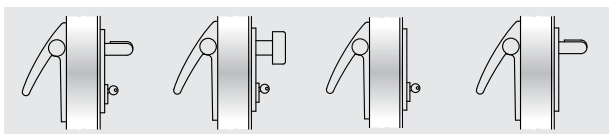

BM

BSP

BS

BMC

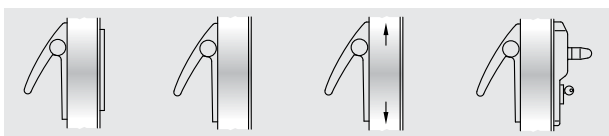

BC

B

A

ELM

## VARIATIONS ON REQUEST (see dedicated page)

- Aluminum bar painted in RAL colors
- External BM, BSP, BS, BMC and BC commands in brushed stainless steel
- External BM and BSP commands painted in RAL colors
- MAC1 panic lock with access control mode, combinable with the BM version
- Mastered or encrypted cylinders
- Microswitch and cable sleeve for signaling when the door is open

## TWIST (SUPPLIED WITH THE DOOR)

### For single leaf or the active leaf of two-leaved doors:

*Included (mounted on the door):* the anti-panic lock with 65mm entrance and the strike box lock insert

*Included (in the package):* Nr. 2 mechanisms, Nr. 2 black plastic carter covers, Nr. 2 black plastic lever arms, Nr. 1 anodized aluminum bar, Nr. 1 black plastic external door furniture, Nr. 1 half-cylinder with 3 keys, Nr. 1 drilling template, Nr. 1 adhesive pictogram (green arrow), Nr. 1 set of installation/maintenance instructions

*Versions available:* BM, BSP, BS, BMC, BC, B (for Proget doors only), ELM

ELM electric handle: see the dedicated pages

### For the inactive leaf of two-leaved doors:

*Included (mounted on the door):* anti-panic safety lock with 80mm entrance, the upper re-latch device, the upper strike plate and the vertical rods

*Included (in the package):* Nr. 2 mechanisms, Nr. 2 black plastic carter covers, Nr. 2 black plastic lever arms, Nr. 1 anodized aluminum bar, Nr. 1 floor-mounted door catch, Nr. 1 carrier arm (for fire doors only), Nr. 1 drilling template, Nr. 1 adhesive pictogram (green arrow), Nr. 1 set of installation/maintenance instructions

*Versions available:* A

## TWIST KIT

### (SUPPLIED SEPARATELY FROM THE DOOR)

#### KIT for single leaf or the active leaf of two-leaved doors:

Please specify leaf thickness and door type - REVER, UNIVER or PROGET - in the order

*KIT contents:* Nr. 1 anti-panic lock with 65mm entrance, Nr. 1 strike box lock insert, Nr. 2 mechanisms, Nr. 2 black plastic carter covers, Nr. 2 black plastic lever arms, Nr. 1 anodized aluminum bar, Nr. 1 black plastic external door furniture, Nr. 1 half-cylinder with 3 keys, Nr. 1 drilling template, Nr. 1 adhesive pictogram (green arrow), Nr. 1 set of installation/maintenance instructions

*Versions available:* BM, BSP, BS, BMC, BC

#### KIT for the inactive leaf of two-leaved doors, suited for REVER, UNIVER and PROGET fire and multipurpose doors (produced after 01.01.2005):

specify door type on the order form  
*KIT contents:* Nr. 1 anti-panic safety lock with 80mm entrance, Nr. 2 mechanisms, Nr. 2 black plastic carter covers, Nr. 2 black plastic lever arms, Nr. 1 anodized aluminum bar, Nr. 1 upper re-latch device, Nr. 1 floor-mounted floor catch, Nr. 1 carrier arm (excluding REVER and UNIVER MULTIPURPOSE), Nr. 1 drilling template, Nr. 1 adhesive pictogram (green arrow), Nr. 1 set of installation/maintenance instructions

*Versions available:* A

#### KIT for the inactive leaf of two-leaved doors and suited for other types of multipurpose doors and for substitution of non CE marked panic bars (PROGET doors):

*KIT contents:* Nr. 1 anti-panic safety lock with 80mm entrance, Nr. 2 mechanisms, Nr. 2 black plastic carter covers, Nr. 2 black plastic lever arms, Nr. 1 anodized aluminum bar, Nr. 1 upper re-latch device, Nr. 1 upper strike plate, vertical rods, Nr. 1 floor-mounted floor catch, Nr. 1 carrier arm, Nr. 1 drilling template, Nr. 1 adhesive pictogram (green arrow), Nr. 1 set of installation/maintenance instructions

*Versions available:* A

**REVER**  
multipurpose

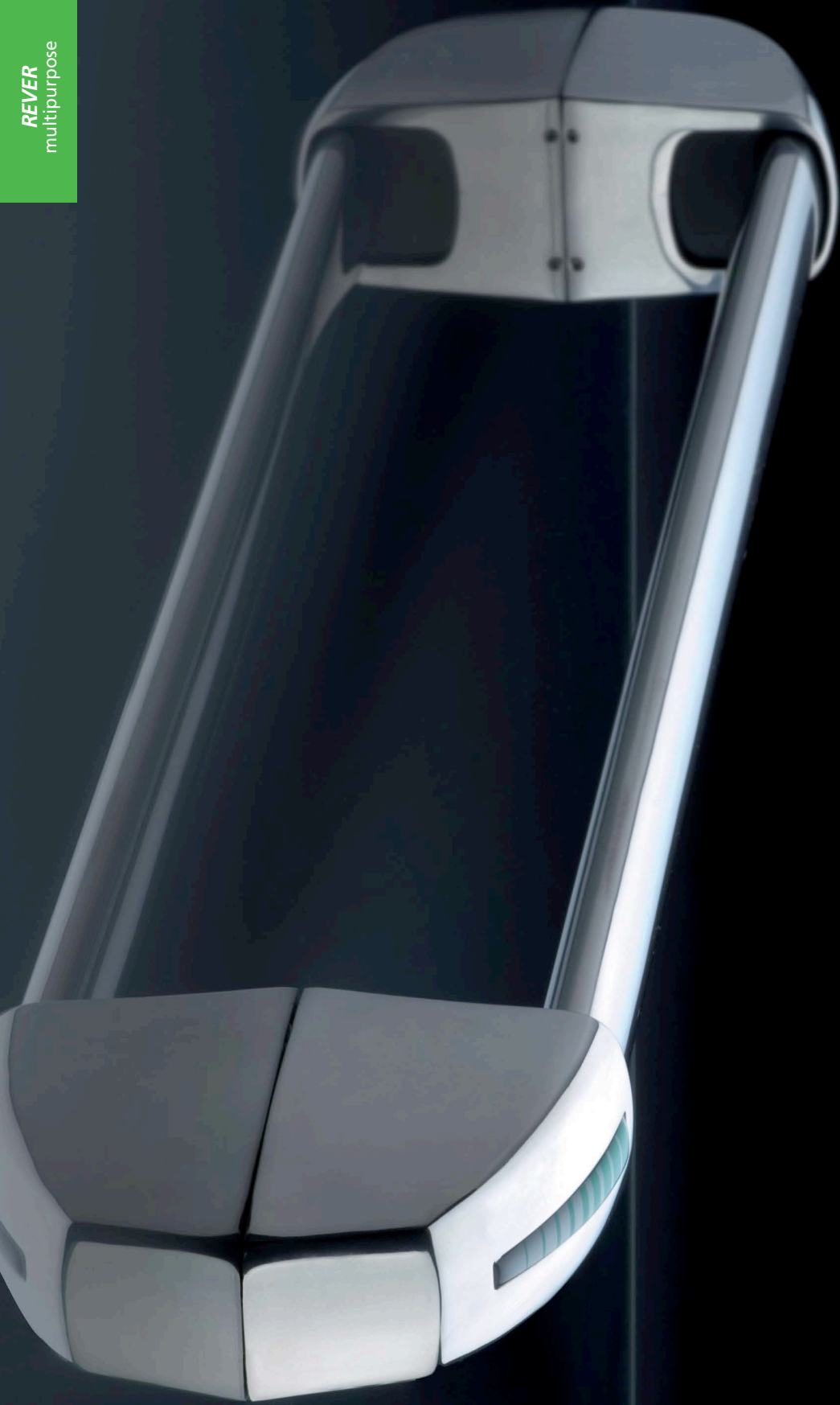



## PRESENTATION

### SLASH panic bars

Ninz S.p.A. is a leader in fire doors, and has once again reasserted itself as a visionary company with a strong identity created by its continuous research into the design and technology of its own products, such as the new line of SLASH panic bars.

All SLASH handles are **CE** marked and pre-certified according to European standard EN 1125:2008, which entered in effect January 01, 2010, to prescribe a series of substantial changes that further extend the requirements for maximum safety and ease of opening.

### The KIT designed for your needs

When ordered separately from the door, the **SLASH** series of panic bars is provided in elegant and functional KITS packaged for presentation in the most appropriate distribution format.

Packaging in KITS ensures customers, installers and therefore the final users that they are receiving a complete anti-panic system with fully corresponding parts that are all **CE** certified.

### Finishing

In addition to the **black PLASTIC** version combined with **anodized ALUMINUM** bars, new combinations include the **brushed STAINLESS STEEL** version and the **polished chromed ALUMINUM** version combined with the **anodized ALUMINUM bar**. Many other color and surface combinations are possible for equally aesthetic solutions.

### Certifications and replacements

Given the importance of maintaining the entire system's **CE** conformity, special attention has been paid to replacement parts, which have been subjected to testing in accordance with the EN 1125:2008 standard due to their pivotal role in maintaining **CE** certification.

The only way to ensure that the products maintain their original characteristics over time is by using **original NINZ replacement parts**.

For this reason, the instructions for **SLASH** panic bars include additional indications regarding proper installation and maintenance plus a blow-up drawing that specifies every smallest detail of the certified system with all of the references required for ordering replacement parts.

With the expansion of the line and the new packaging of the SLASH panic bar, NINZ S.p.A. demonstrates its faith in market development by investing in designs and company image in order to endow its fire doors and the series of accessories with added value while continuing to maintain highly competitive quality-price ratios.



Black PLASTIC handle



Brushed STAINLESS STEEL handle

### NOTE

By default external door furniture is provided with the same finishing as the panic bar.

# SLASH - Features, certifications

Panic bar



REVER  
multipurpose

## FEATURES

- Panic bar that stands out from the others due to its particular design and the rounded shapes of the carters. This characteristic not only improves aesthetic appeal, but it also eliminates any risk of injury during use
- Available in different color and surface combinations, in brushed stainless steel for the cover carters and the bar, or with polished chromed aluminum carters and anodized aluminum bar, and then there is always the classic combination that is still in fashion - black plastic carters with anodized aluminum bar
- Certified for internal locks with a 65mm entrance for single leaves or active leaves, and with an 80mm entrance for inactive leaves
- Reversible for Right or Left mounting
- Protrusion 75mm
- Proposed together with the door or separately in a complete KIT packaged in a single black/orange box
- Label applied to the packaging to identify the product's characteristics
- Wide range of customizations: colored bar, colored or stainless steel handles, lock with access control mechanisms, special encrypted or mastered cylinders

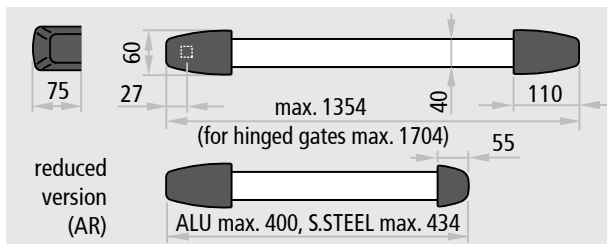

Also suited for doors with classifications up to:



## CERTIFICATION

Suited for one-leaved doors or the active and inactive leaves of two-leaved doors with dimensions up to 1350x2880mm/leaf, mass up to 300kg/leaf.

<b>CE</b>	
<b>Denomination</b>	SLASH PANIC BAR
<b>Manufacturer</b>	Ninz S.p.A. Corso Trento, 2/A I-38061 ALA (TN)/ITALY
<b>Year application trademark</b>	08
<b>Nr. and year of the standard</b>	EN 1125:2008
<b>Certifying body</b>	0425
<b>CE certificate Nr.</b>	1308-CPD-2007
<b>Classification</b>	<b>3 7 7 B 1 3 2 2 B A</b>

- 1st Category of use very frequent
- 2nd Durability 200.000 cycles
- 3rd Door mass over 200 kg
- 4th Suitable for fire/smoke rated doors
- 5th Safety, suitable for evacuation routes
- 6th High corrosion resistance 96 h
- 7th Material safety 1000 N
- 8th Bar protrusion up to 100 mm
- 9th Activation type with touch bar
- 10th Suitable for one- or two-leaved doors

ATTESTATO DI CONFORMITÀ DIRETTIVA 89/106/CEE CERTIFICATE OF CONFORMITY DIRECTIVE 89/106/CEE		CE 0425
Questo certificato è rilasciato in conformità a quanto prescritto dall'Art.6 par.2 lettera b) del DPR 21 aprile 1993, n°246 (Direttiva 89/106/CEE) ed attesta la conformità del prodotto di seguito identificato agli Art.1, Art.2 ed allegato A del DPR 21 aprile 1993, n°246 (Direttiva 89/106/CEE). This certificate has been issued in conformity to what prescribed by the Art.6 par.2 letter b) of the DPR 21/04/1993, n°246 (Directive 89/106/EEC) and certifies the conformity of the product described below to the Art.1, Art.2 and attachment A of DPR 21/04/1993, n°246 (Directive 89/106/EEC).		
<b>ATTESTATO N°</b>	<b>1308 - CPD - 2007</b>	<b>CERTIFICATE N°</b>
<b>Organismo notificato</b>	ICIM S.p.A. - Piazza Don Mapelli, 75 - 20099 Sesto San Giovanni (MI) ITALY	<b>Notified Body</b> Identification number: 0425
<b>Dati Fabbricante</b>	Sede legale: NINZ S.p.A. Corso Trento, 2/A 38061 ALA (TN) ITALY Unità operativa:	<b>Manufacturer</b> Head office Operative unit
<b>Dati prodotto</b>	<b>DISPOSITIVI ANTIPANICO PER USCITE DI SICUREZZA AZIONATI MEDIANTE UNA BARRA ORIZZONTALE</b> <b>PANIC EXIT DEVICES</b>	<b>Product</b> Type
Denominazione	Dispositivo antipanico	Modelli "SLASH", "SLASH AR", "SLASH ALU", "SLASH ALU AR", "SLASH INOX", "SLASH INOX AR".
Serrature antipanico	art. AP16/18, SCA 1 3201001.019020, MAC 1 3201001.041042, 3201001.018, 405/55-0	
Controserrature antipanico	art. AP020P, AP020U, 3201001.6, 43190-95.	
Dispositivo superiore	art. 3105080, 3105024, 3305003.	
Riscontro asta	art. 2401006, 2401046, 2401044, 2401002.	
Boccola pavimento	art. 2401001, 2401007, 3105091, 2401020, 4419008.	
Deviatori	art. 4201010.	
Aste verticali	art. 3305015, 3305016, 3305002, 3305013, 990837.	
Riscontro serratura	art. 2401006, 2401005, 2401015, 2401014, 2401006, 2401035, 3412001.	
Comandi esterni	art. BM, BSP, BS, BMC, BC, B, A, BM inox, BM alu, BSP inox, BSP alu.	
Sistema di attestazione della conformità	1	Attestation of conformity
Norma di riferimento	EN1125:2008	Standard
Classificazione	<b>3   7   7   B   1   3   2   2   B   A</b>	Classification
<b>Eventuali estensioni</b>	Nessuna / None	<b>Extensions</b>
<b>Eventuali condizioni di subordinazione della Certificazione CE</b>	Nessuna / None	<b>Possible conditions of subordination of the CE Certification</b>
Il presente attestato è valido esclusivamente per il prodotto indicato. Eventuali varianti da apportare devono essere approvate da ICIM SpA. The present issue is valid only for the product described above. Possible changes to be brought in have to be approved by ICIM S.p.A.		
<b>Data di emissione</b> First issue	<b>Emissione corrente</b> Current issue	<b>Data di scadenza</b> Expiring date
31/05/2007	04/08/2010	30/05/2017
		ICIM S.p.A. Il Presidente Ing. Tullio Badino

## SLASH IN BLACK PLASTIC



### Description

The SLASH panic bar consists of an anodized aluminum horizontal bar and an internal connection tube that inserts into the mechanisms which activate the lock.

- Reversible for right or left opening
- For application to single leaf and two-leaved doors
- Suited for Rever/Univer/Proget doors and other types of panic exit doors
- The horizontal bar is made of extruded anodized aluminum with an elliptical cross-section measuring 40x20mm and a length of 1150mm, equipped with a connection tube
- The two mechanisms are made of galvanized steel with black plastic carter covers, one of which has a green label that identifies the lock side
- The lock is anti-panic/fire rated for Euro profile cylinders
- The door furnitures and the cover plates are made of black plastic, while the installation plate is made of galvanized steel

## VERSIONS AVAILABLE

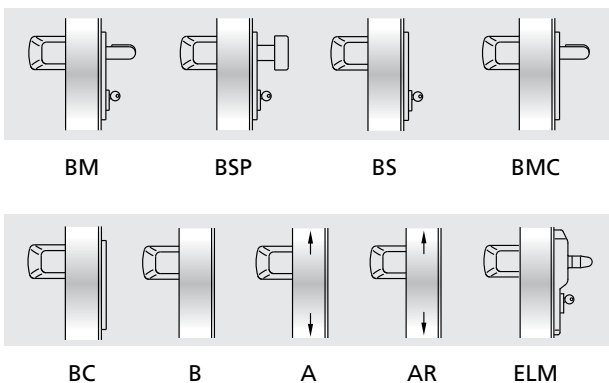

## VARIATIONS ON REQUEST (see dedicated page)

- Aluminum bar painted in RAL colors
- External BM, BSP, BS, BMC and BC commands in brushed stainless steel
- External BM and BSP commands painted in RAL colors
- MAC1 panic lock with access control mode, combinable with BM versions
- Mastered or encoded cylinders
- Microswitch and cable sleeve for signaling when the door is open

## SLASH (SUPPLIED WITH THE DOOR)

### For single leaf or the active leaf of two-leaved doors:

*Included (mounted on the door):* the anti-panic lock with 65mm entrance and the strike box lock insert

*Included (in the package):* Nr. 2 mechanisms, Nr. 2 black plastic carter covers, Nr. 1 anodized aluminum bar with connection tube and spacer, Nr. 1 hole cover in RAL 9006 colored plastic with base plate (for REVER and UNIVER doors), Nr. 1 black plastic external door furniture, Nr. 1 half-cylinder with 3 keys, Nr. 1 drilling template, Nr. 1 adhesive pictogram (green arrow), Nr. 1 set of installation/maintenance instructions

*Versions available:* BM, BSP, BS, BMC, BC, B (for Proget doors only), ELM ELM electric handle: see the dedicated pages

### For the inactive leaf of two-leaved doors:

*Included (mounted on the door):* anti-panic safety lock with 80mm entrance, the upper re-latch device, the upper strike plate and the vertical rods

*Included (in the package):* Nr. 2 mechanisms, Nr. 2 black plastic carter covers, Nr. 1 anodized aluminum bar with connection tube and spacer, Nr. 1 floor-mounted floor catch, Nr. 1 carrier arm (for fire doors only), Nr. 1 drilling template, Nr. 1 adhesive pictogram (green arrow), Nr. 1 set of installation/maintenance instructions

*Versions available:* A, AR (reduced) for inactive leaves with FM L2 width ≤ 500mm

## SLASH KIT

### (SUPPLIED SEPARATELY FROM THE DOOR)

#### KIT for single leaf or the active leaf of two-leaved doors:

Please specify leaf thickness and door type - REVER, UNIVER or PROGET - in the order

*KIT contents:* Nr. 1 anti-panic lock with 65mm entrance, Nr. 1 strike box lock insert, Nr. 2 mechanisms, Nr. 2 black plastic carter covers, Nr. 1 anodized aluminum bar with connection tube and spacer, Nr. 1 hole cover in RAL 9006 colored plastic with base plate, Nr. 1 black plastic external door furniture, Nr. 1 half-cylinder with 3 keys, Nr. 1 drilling template, Nr. 1 adhesive pictogram (green arrow), Nr. 1 set of installation/maintenance instructions

*Versions available:* BM, BSP, BS, BMC, BC

#### KIT for the inactive leaf of two-leaved doors, suited for REVER, UNIVER and PROGET fire and multipurpose doors (produced after 01.01.2005):

*KIT contents:* Nr. 1 anti-panic safety lock with 80mm entrance, Nr. 2 mechanisms, Nr. 2 black plastic carter covers, Nr. 1 anodized aluminum bar with connection tube and spacer, Nr. 1 upper re-latch device, Nr. 1 floor-mounted floor catch, Nr. 1 carrier arm (excluding REVER and UNIVER MULTIPURPOSE), Nr. 1 drilling template, Nr. 1 adhesive pictogram (green arrow), Nr. 1 set of installation/maintenance instructions

*Versions available:* A, AR (reduced) for use with inactive leaves with FM L2 width ≤ 500mm

#### KIT for the inactive leaf of two-leaved doors and suited for other types of multipurpose doors and for substitution of non CE marked panic bars (PROGET doors):

*KIT contents:* Nr. 1 anti-panic safety lock with 80mm entrance, Nr. 2 mechanisms, Nr. 2 black plastic carter covers, Nr. 1 anodized aluminum bar with connection tube and spacer, Nr. 1 upper re-latch device, Nr. 1 strike plate, vertical rods, Nr. 1 floor-mounted floor catch, Nr. 1 carrier arm, Nr. 1 drilling template, Nr. 1 adhesive pictogram (green arrow), Nr. 1 set of installation/maintenance instructions

*Versions available:* A, AR (reduced) for use with inactive leaves with FM L2 width ≤ 500mm

**SLASH IN ALUMINUM**

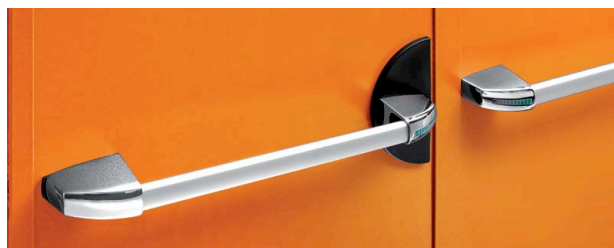

**Description**

The SLASH ALU panic bar consists of an anodized aluminum horizontal bar and an internal connection tube that inserts into the mechanisms which activate the lock.

- Reversible for right or left opening
- For application to single leaf and two-leaved doors
- Suited for Rever/Univer/Proget doors and other types of panic exit doors
- The horizontal bar is made of extruded anodized aluminum with an elliptical cross-section measuring 40x20mm and a length of 1150mm, equipped with a connection tube
- The two mechanisms are made of galvanized steel with aluminum alloy carter covers with polished chrome finishing, one of which has a green label to identify the lock side
- The lock is anti-panic/fire rated for Euro profile cylinders
- The external door furnitures and related cover plates are made of AISI 304 brushed stainless steel, while the installation plate is made of galvanized steel
- The carters are finished with tri-valent chrome in compliance with the ROSH regulation

**NOTE**

It is not advisable to use the anti-panic bar SLASH ALU for marine environments or in particularly humid areas. For these situations the use of the anti-panic bar SLASH S.S. is recommended.

**VERSIONS AVAILABLE**

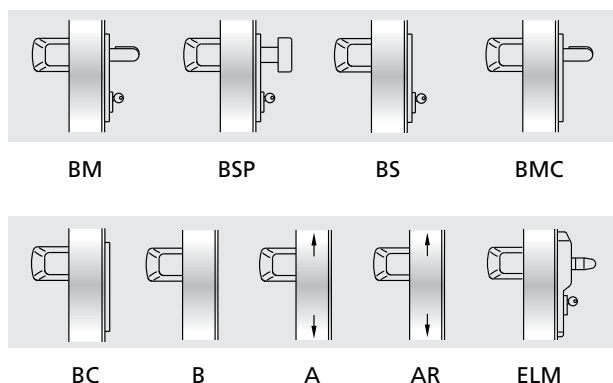

**VARIATIONS ON REQUEST** (see dedicated page)

- Aluminum bar painted in RAL colors
- MAC1 panic lock with access control system, combinable with BM versions
- Mastered or encoded cylinders
- Microswitch and cable sleeve for signaling when the door is open

**SLASH ALU (SUPPLIED WITH THE DOOR)**

**For single leaf or the active leaf of two-leaved doors:**

*Included (mounted on the door):* the anti-panic lock with 65mm entrance and the strike box lock insert

*Included (in the package):* Nr. 2 mechanisms, Nr. 2 polished chrome aluminum carter covers, Nr. 1 anodized aluminum bar with connection tube and spacer, Nr. 1 hole cover in black plastic with base plate (for REVER and UNIVER doors), Nr. 1 stainless steel external door furniture, Nr. 1 half-cylinder with 3 keys, Nr. 1 drilling template, Nr. 1 adhesive pictogram (green arrow), Nr. 1 set of installation/maintenance instructions

*Versions available:* BM, BSP, BS, BMC, BC, B (for Proget doors only), ELM ELM electric handle: see the dedicated pages

**For the inactive leaf of two-leaved doors:**

*Included (mounted on the door):* anti-panic safety lock with 80mm entrance, the upper re-latch device, the upper strike plate and the vertical rods

*Included (in the package):* Nr. 2 mechanisms, Nr. 2 polished chrome aluminum carter covers, Nr. 1 anodized aluminum bar with connection tube and spacer, Nr. 1 floor-mounted floor catch, Nr. 1 carrier arm (for fire doors only), Nr. 1 drilling template, Nr. 1 adhesive pictogram (green arrow), Nr. 1 set of installation/maintenance instructions

*Versions available:* A, AR (reduced) for inactive leaves with FM L2 width ≤ 500mm

**SLASH ALU KIT**

**(SUPPLIED SEPARATELY FROM THE DOOR)**

**KIT for single leaf or the active leaf of two-leaved doors:**

Please specify leaf thickness and door type - REVER, UNIVER or PROGET - in the order

*KIT contents:* Nr. 1 anti-panic lock with 65mm entrance, Nr. 1 strike box lock insert, Nr. 2 mechanisms, Nr. 2 polished chrome aluminum carter covers, Nr. 1 anodized aluminum bar with connection tube and spacer, Nr. 1 hole cover in black plastic with base plate, Nr. 1 stainless steel external door furniture, Nr. 1 half-cylinder with 3 keys, Nr. 1 drilling template, Nr. 1 adhesive pictogram (green arrow), Nr. 1 set of installation/maintenance instructions

*Versions available:* BM, BSP, BS, BMC, BC

**KIT for the inactive leaf of two-leaved doors, suited for REVER, UNIVER and PROGET fire and multipurpose doors (produced after 01.01.2005):** specify door type on the order form

*KIT contents:* Nr. 1 anti-panic safety lock with 80 mm entrance, Nr. 2 mechanisms, Nr. 2 polished chrome aluminum carter covers, Nr. 1 anodized aluminum bar with connection tube and spacer, Nr. 1 upper re-latch device, Nr. 1 floor-mounted floor catch, Nr. 1 carrier arm (excluding REVER and UNIVER MULTIPURPOSE), Nr. 1 drilling template, Nr. 1 adhesive pictogram (green arrow), Nr. 1 set of installation/maintenance instructions

*Versions available:* A, AR (reduced) for use with inactive leaves with FM L2 width ≤ 500mm

**KIT for the inactive leaf of two-leaved doors and suited for other types of multipurpose doors and for substitution of non CE marked panic bars (PROGET doors):**

*KIT contents:* Nr. 1 anti-panic safety lock with 80mm entrance, Nr. 2 mechanisms, Nr. 2 polished chromed aluminum carter covers, Nr. 1 anodized aluminum bar with connection tube and spacer, Nr. 1 upper re-latch device, Nr. 1 upper strike plate, vertical rods, Nr. 1 floor-mounted floor catch, Nr. 1 carrier arm, Nr. 1 drilling template, Nr. 1 adhesive pictogram (green arrow), Nr. 1 set of installation/maintenance instructions

*Versions available:* A, AR (reduced) for use with inactive leaves with FM L2 width ≤ 500mm

# SLASH STAINLESS STEEL

Panic bar for internal locks - CEN EN 1125:2008



REVER multipurpose

## SLASH IN STAINLESS STEEL



### Description

The SLASH STAINLESS STEEL panic bar consists of a stainless steel horizontal bar and an internal connection tube that inserts into the mechanisms which activate the lock.

- Optimal corrosion and shock resistance
- State of the art aesthetics
- Secure attachment of carter covers
- Reversible for right or left opening
- For application to single leaf and two-leaved doors
- Suited for Rever/Univer/Proget doors and other types of panic exit doors
- The horizontal bar is made of AISI 304 brushed stainless steel with a 40x20mm elliptical cross-section and a length of 1150mm, equipped with a connection tube
- The two mechanisms are made of galvanized steel with AISI 304 stainless steel cover plates, one of which has a green label that identifies the lock side
- The lock is anti-panic/fire rated for Euro profile cylinders
- The external door furnitures and related cover plates are made of AISI 304 brushed stainless steel, while the installation plate is made of galvanized steel

## VERSIONS AVAILABLE

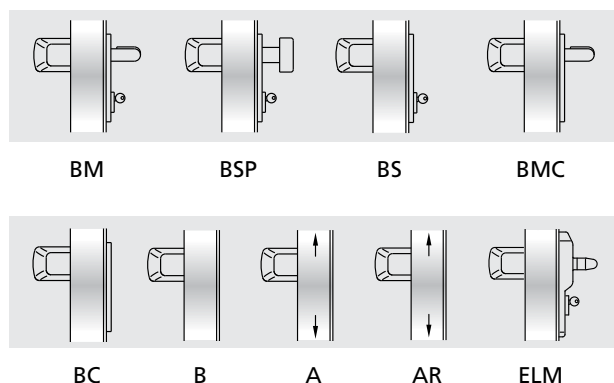

## VARIATIONS ON REQUEST (see dedicated page)

- MAC1 panic lock with access control system, combinable with BM versions
- Mastered or coded cylinders
- Microswitch and cable sleeve for signaling when the door is open

## SLASH STAINLESS STEEL (SUPPLIED WITH THE DOOR)

### For single leaf or the active leaf of two-leaved doors:

*Included (mounted on the door):* the anti-panic lock with 65mm entrance and the strike box lock insert

*Included (in the package):* Nr. 2 mechanisms, Nr. 2 stainless steel carter covers, Nr. 1 stainless steel bar with connection tube and spacer, Nr. 1 hole cover in black-colored plastic with base plate (for REVER and UNIVER doors), Nr. 1 stainless steel external door furniture, Nr. 1 half-cylinder with 3 keys, Nr. 1 drilling template, Nr. 1 adhesive pictogram (green arrow), Nr. 1 set of installation/maintenance instructions

*Versions available:* BM, BSP, BS, BMC, BC, B (for Proget doors only), ELM  
ELM electric handle: see the dedicated pages

### For the inactive leaf of two-leaved doors:

*Included (mounted on the door):* anti-panic safety lock with 80mm entrance, the upper re-latch device, the upper strike plate and the vertical rods

*Included (in the package):* Nr. 2 mechanisms, Nr. 2 stainless steel carter covers, Nr. 1 stainless steel bar with connection tube and spacer, Nr. 1 floor-mounted floor catch, Nr. 1 carrier arm (for fire doors only), Nr. 1 drilling template, Nr. 1 adhesive pictogram (green arrow), Nr. 1 set of installation/maintenance instructions

*Versions available:* A, AR (reduced) for inactive leaves with FM L2 width ≤ 500mm

## SLASH STAINLESS STEEL KIT (SUPPLIED SEPARATELY FROM THE DOOR)

### KIT for single leaf or the active leaf of two-leaved doors:

Please specify leaf thickness and door type - REVER, UNIVER or PROGET - in the order

*KIT contents:* Nr. 1 anti-panic lock with 65mm entrance, Nr. 1 strike box lock insert, Nr. 2 mechanisms, Nr. 2 stainless steel carter covers, Nr. 1 stainless steel bar with connection tube and spacer, Nr. 1 hole cover in black plastic with base plate, Nr. 1 stainless steel door furniture, Nr. 1 half-cylinder with 3 keys, Nr. 1 drilling template, Nr. 1 adhesive pictogram (green arrow), Nr. 1 set of installation/maintenance instructions

*Versions available:* BM, BSP, BS, BMC, BC

### KIT for the inactive leaf of two-leaved doors, suited for REVER, UNIVER and PROGET fire and multipurpose doors (produced after 01.01.2005):

specify door type on the order form  
*KIT contents:* Nr. 1 anti-panic safety lock with 80mm entrance, Nr. 2 mechanisms, Nr. 2 stainless steel carter covers, Nr. 1 stainless steel bar with connection tube and spacer, Nr. 1 upper re-latch device, Nr. 1 floor-mounted floor catch, Nr. 1 carrier arm (excluding REVER and UNIVER MULTIPURPOSE), Nr. 1 drilling template, Nr. 1 adhesive pictogram (green arrow), Nr. 1 set of installation/maintenance instructions

*Versions available:* A, AR (reduced) for use with inactive leaves with FM L2 width ≤ 500mm

### KIT for the inactive leaf of two-leaved doors and suited for other types of multipurpose doors and for substitution of non CE marked panic bars (PROGET doors):

*KIT contents:* Nr. 1 anti-panic safety lock with 80mm entrance, Nr. 2 mechanisms, Nr. 2 stainless steel cover plates, Nr. 1 stainless steel bar with connection tube and spacer, Nr. 1 upper re-latch device, Nr. 1 upper strike plate, vertical rods, Nr. 1 floor-mounted floor catch, Nr. 1 carrier arm, Nr. 1 drilling template, Nr. 1 adhesive pictogram (green arrow), Nr. 1 set of installation/maintenance instructions

*Versions available:* A, AR (reduced) for use with inactive leaves with FM L2 width ≤ 500mm

### COMPONENTS OF THE CERTIFIED SYSTEM

All NINZ panic bars are supplied in complete KITS to ensure conformity with EN 1125:2008 standards and **CE** certification of the product. When supplied together with the door, several of these components are already mounted

on the leaf and/or doorframe. The purpose of the following examples is to help clarify what panic bars must include to comply with certified samples.

#### Certified components of the EXUS system for one-leaved doors:

1. panic bar (1a. mechanisms, 1b. carters, 1c. carrier arms, 1d. horizontal bar, 1e. adhesive pictogram)
- 2a. panic safe lock for single or active leaf
3. strike box lock
4. external operation
- 9a. square spindle
10. half cylinder or cylinder to pass

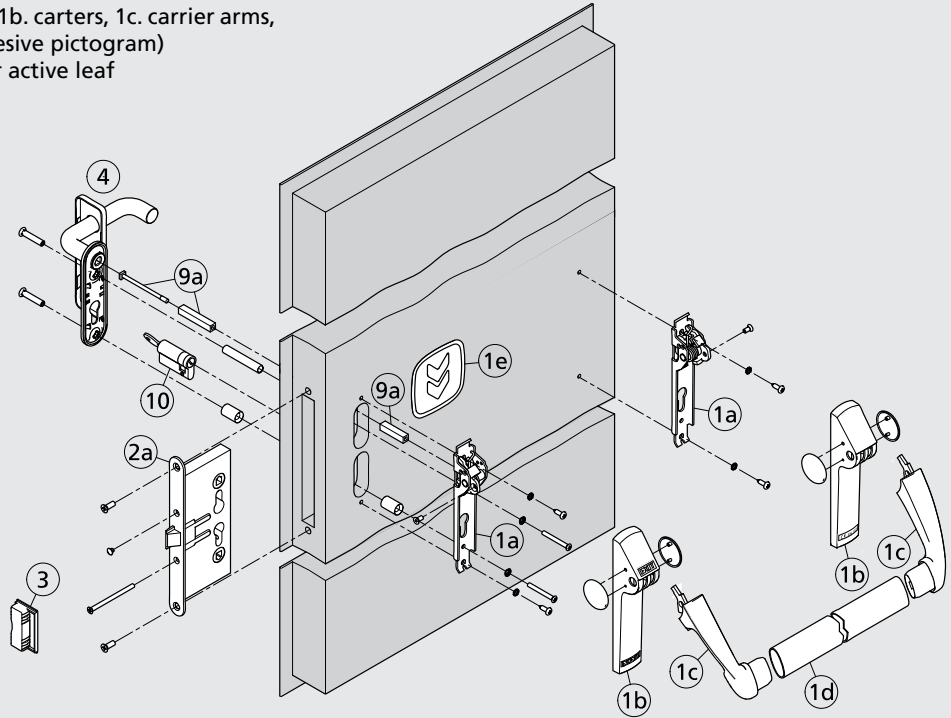

#### Certified components of the EXUS system for inactive leaf of two-leaved doors:

1. panic bar (1a. mechanisms, 1b. carters, 1c. carrier arms, 1d. horizontal bar, 1e. adhesive pictogram)
- 2b. panic safe lock for inactive leaf
5. upper bolt device
6. strike box with roller
7. floor catch set
8. vertical rods (8a. upper, 8b. lower)
- 9b. square spindle
11. carrier arm (mandatory in case of fire-rated doors only)

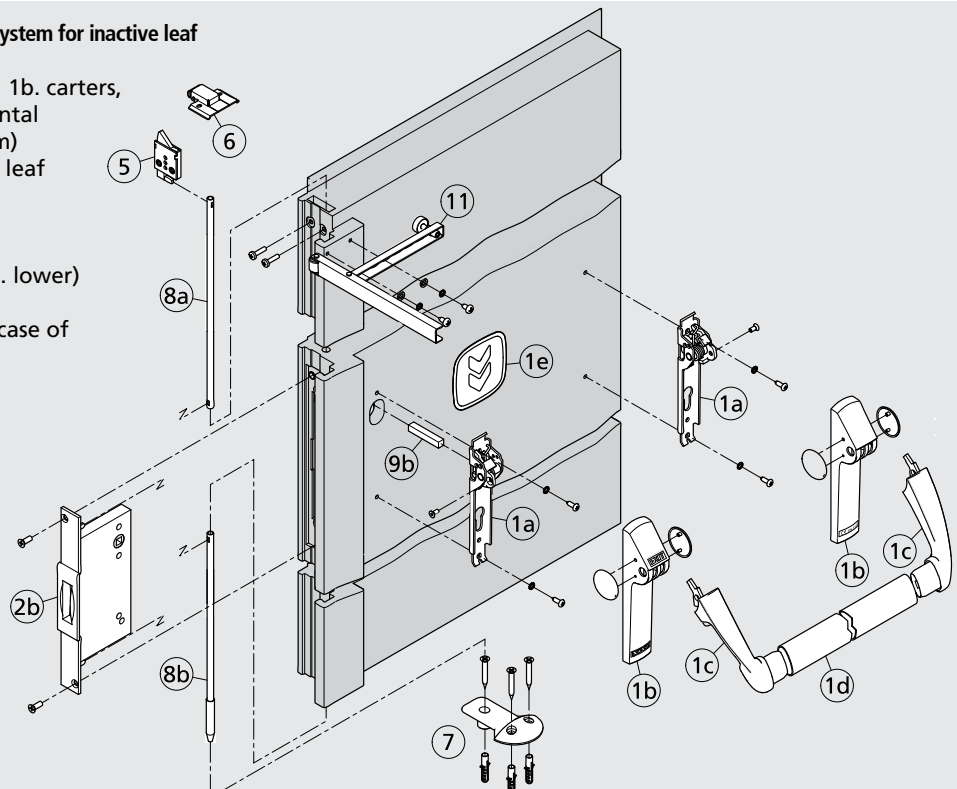

# Variations on request

For panic bars

## STAINLESS STEEL EXTERNAL DOOR FURNITURE

For all black plastic exit devices (except for those designed for glazed doors), brushed stainless steel external BM, BSP, BS BMC and BC commands are available on request.



BM stainless steel

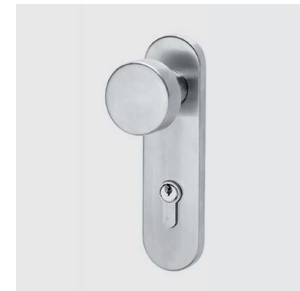

BSP stainless steel

## COLORED PLASTIC EXTERNAL DOOR FURNITURE

For all black plastic exit devices (except for those designed for glazed doors), painted plastic external BM and BSP commands are available on request.

Colors available:				
RAL	RAL	RAL	RAL	RAL
1023	7016	7035	9006*	9010

\*light aluminum

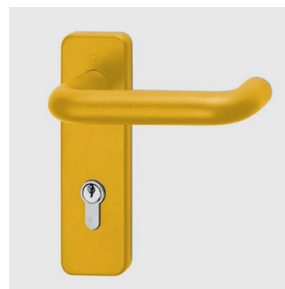

BM colored RAL1023

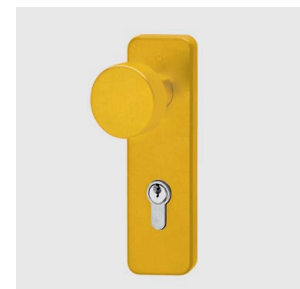

BSP colored RAL1023

## PAINTED HORIZONTAL BAR

For all exit devices (except for those with a stainless steel bar), the aluminum horizontal bar may be painted in the RAL color of your choice.



## VERSION „E“ WITH MICROSWITCH

All exit devices may be equipped with a microswitch incorporated in the hinge side mechanism for signaling when the door is open. The cable and cable sleeve for the electrical connection between the exit device and the wall are included.

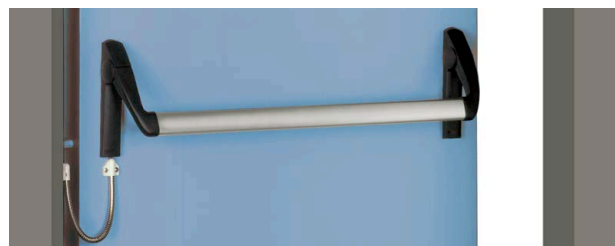

## MAC1<sup>®</sup> AND MAC1<sup>®</sup> FAILSAFE ACCESS CONTROL SYSTEMS

For all exit devices with type BM external door furniture (except for those designed for glazed doors), the panic lock is also available with the access control function. Delivery together with the door includes the following: the MAC1 or MAC1 FAILSAFE lock, external command with LED, internal cabling of the leaf and the electric contacts between the door leaf and door frame. In case of delivery as a Kit with panic bar instead of the internal cabling and the electric contacts a power supply cable and a flexible cable sleeve will be supplied.



Handle for MAC1 and MAC1 FAILSAFE locks with LEDs

### MAC1 and MAC1 FAILSAFE:

- powered at 12-24 V AC/DC
- 250 mA absorption with startup at 500 mA at 12V or max. 1A at 24V
- timer incorporated, time set at 30 seconds
- possibility for continuous handle activation (open setting)

For sizes, information and technical data consult the dedicated pages

# Dimensional drawings

For panic bar components

REVER  
multipurpose

Article Nr.	Description
3201001.016	Lock for one-leaved doors and active leaves (AP 16/18)
3201001.024	Safety lock for inactive leaves (AP 020 P)
3201001.008	Safety lock for inactive leaves of UNIVER multipurpose and REVER (AP 020 U)
3201001.041	MAC1 Left lock
3201001.042	MAC1 Right lock
2401001.001	Lower floor catch for inactive leaf of PROGET and other multipurpose doors
3105019.001	Lower floor catch for inactive leaf of UNIVER
3105020.001	Lower floor catch for inactive leaf of REVER
2401006.001	Strike plate insert for one-leaved PROGET and other multipurpose doors
3105080.001	Upper re-latch device for inactive leaf of PROGET and other multipurpose doors
3105024.001	Upper re-latch device for inactive leaf of UNIVER and REVER
2401046.001	Upper strike box for inactive leaf of PROGET and other multipurpose doors
3305001.001	Carrier arm for inactive leaf

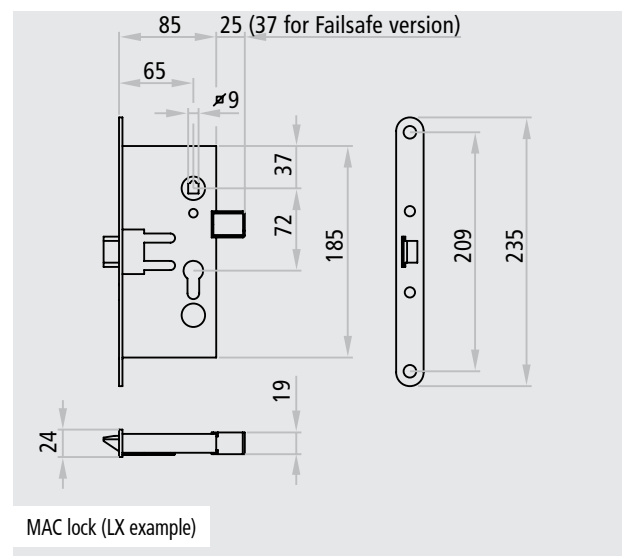
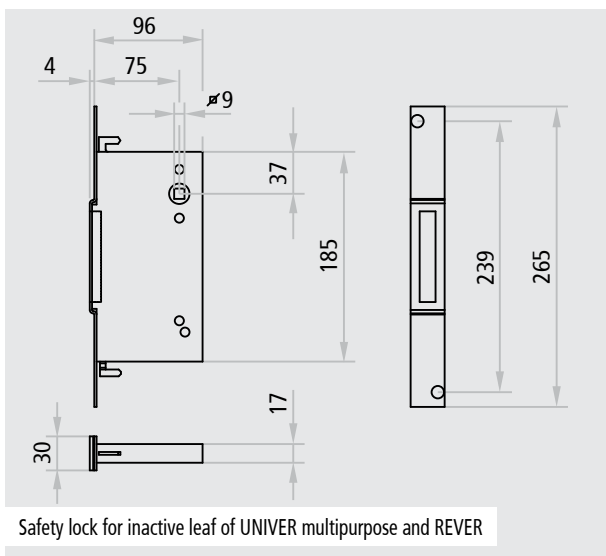
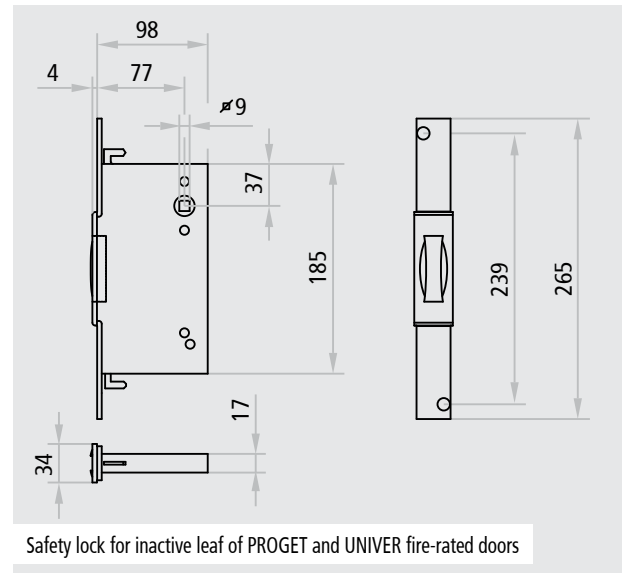
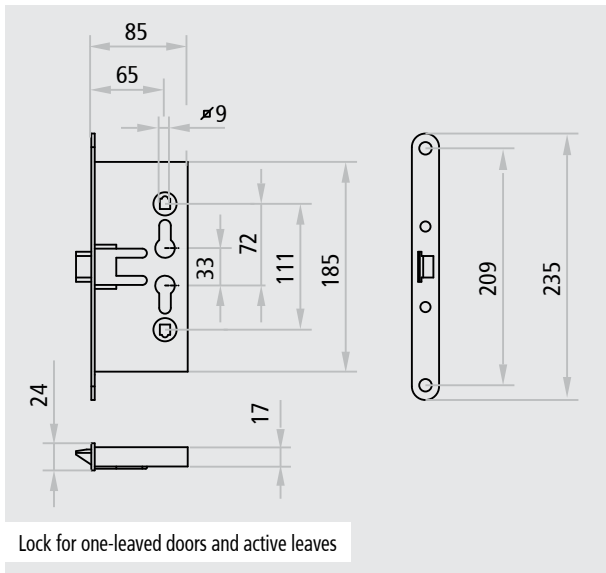



# Dimensional drawings

For panic bar components

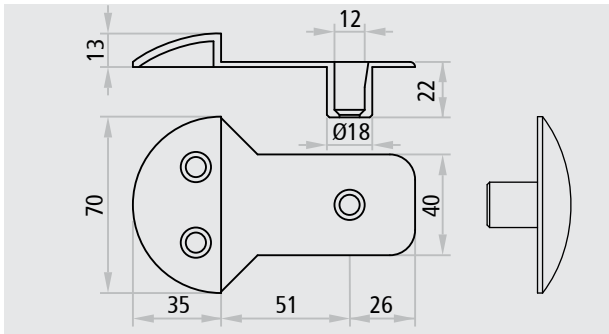

Lower floor catch for inactive leaf of PROGET and other multipurpose doors

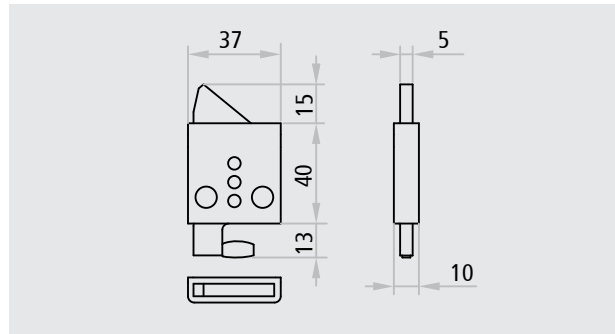

Upper re-latch device for inactive leaf of PROGET and other multipurpose doors

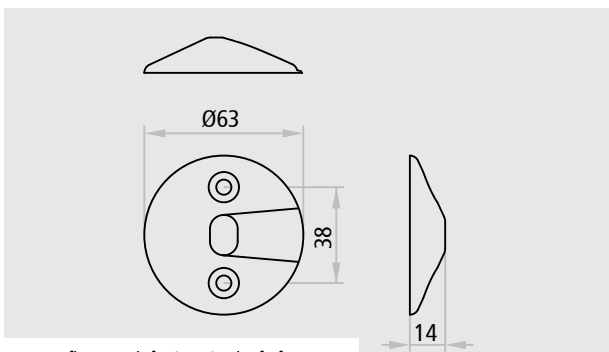

Lower floor catch for inactive leaf of UNIVER

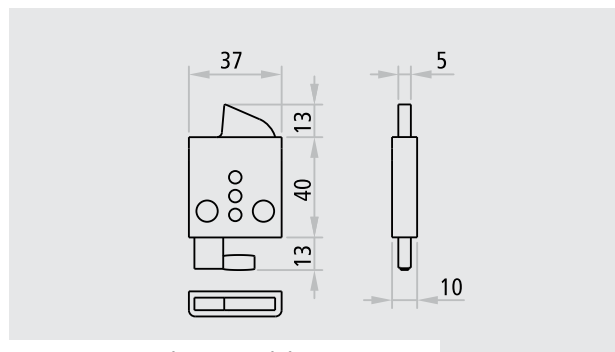

Upper re-latch device for inactive leaf of UNIVER and REVER

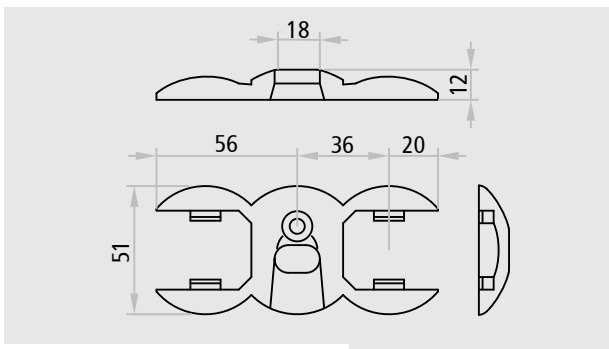

Lower floor catch for inactive leaf of REVER

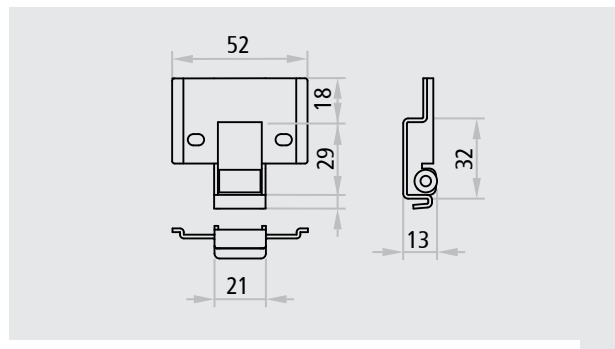

Upper strike box for inactive leaf of PROGET and other multipurpose doors

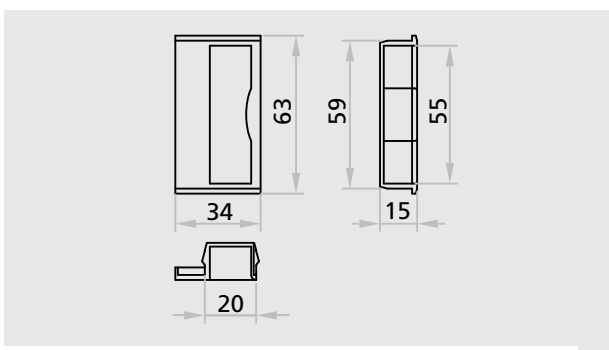

Strike box lock insert for one-leaved doors of PROGET and other multipurpose doors

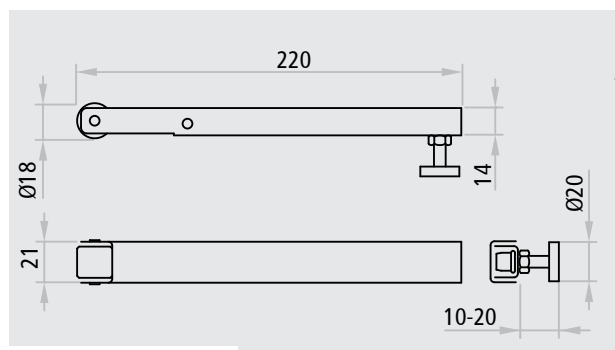

Carrier arm for inactive leaf

5002009/2 - C10  
EDITION 1-2016  
date of print: 22. April 2016



Ninz S.p.A. | Corso Trento 2/A | I-38061 Ala (TN)  
Tel. +39 0464 678 300 | Fax +39 0464 679 025  
info@ninz.it | www.ninz.it