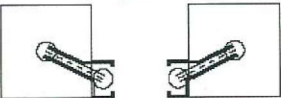
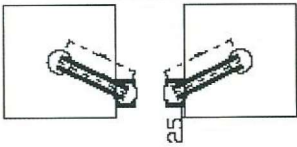
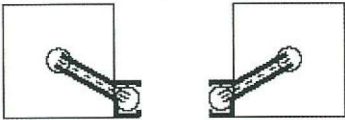
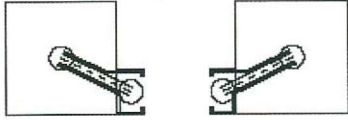
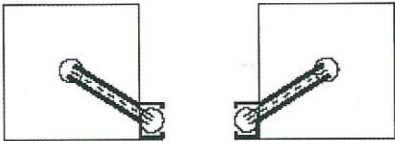
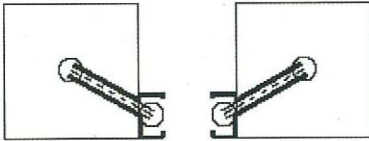
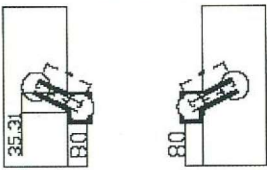
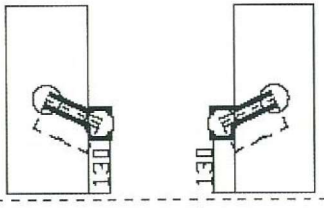
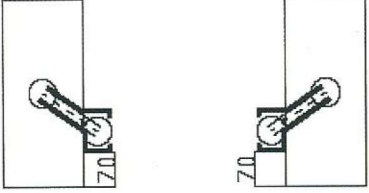
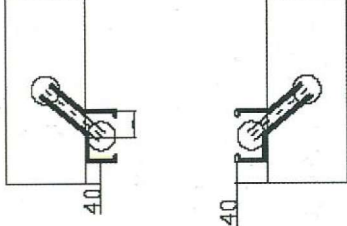
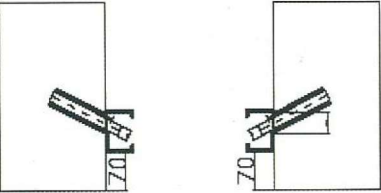
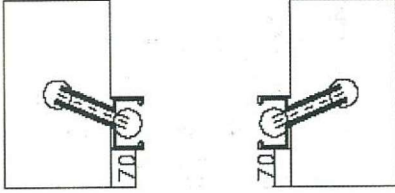

# Puertas Contrapesadas CP 10 Tipo Plegable

## Posicionamiento de los contrapesos

		GUIA DE 60	GUIA DE 80	GUIA DE 100
Contrapesos con cajones cuadrados o forros	Cajón o forro de 200 x 200	Mod.C60 / 200 (cajón) a paño 		
	Cajón o forro de 250 x 250	Mod.C60 / 250 (cajón) 25 mm 	Mod.C80 / 250 (cajón) Mod.F80 / 250 (forro) a paño 	Mod.C100 / 250 (cajón) Mod.F100 / 250 (forro) a paño 
	Cajón o forro de 300 x 300		Mod.C80 / 300 (cajón) Mod.F80 / 300 (forro) a paño 	Mod.C100 / 300 (cajón) Mod.F100 / 300 (forro) a paño 

		GUIA DE 60	GUIA DE 80	GUIA DE 100
Contrapesos con cajones rectangulares	Cajón de 120 x 300	Mod. R60 / 120 90 mm 		
	Cajón de 150 x 350	Mod. R60 / 150 130 mm 	Mod. R80 / 150 70 mm 	Mod. R100 / 150 40 mm 
	Cajón de 200 x 350		Mod. R80 / 200 70 mm 	Mod. R100 / 200 70 mm 

# APERTURA EXTERIOR

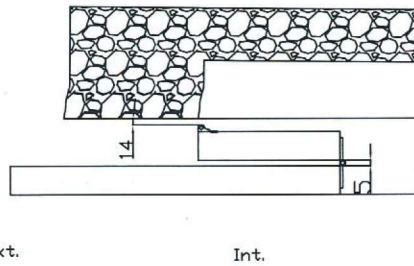
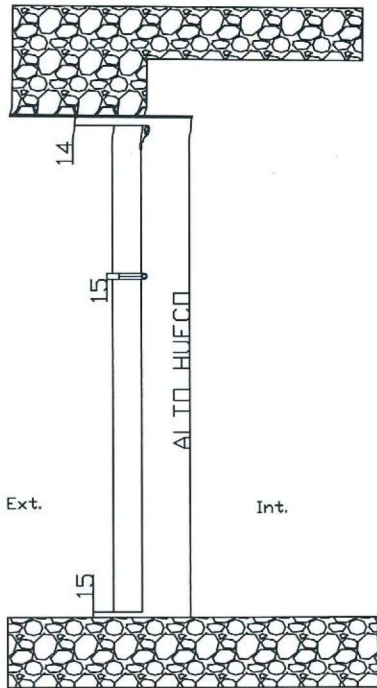

180 Hoja Sección tubular 60x30mm  
 230 Hoja Sección tubular 80x40mm  
 270 Hoja Sección tubular 100x40mm

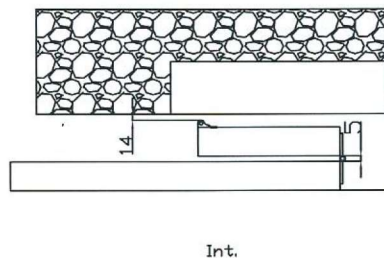
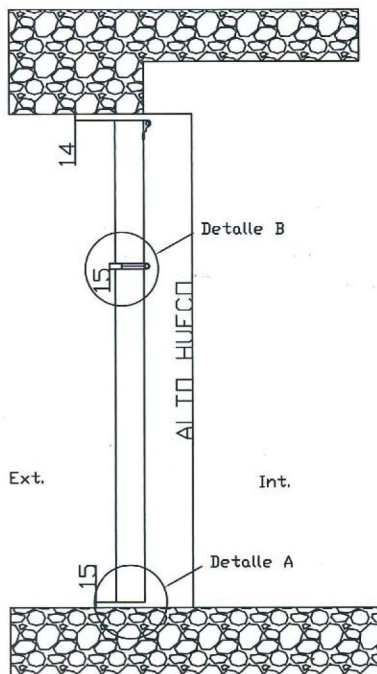

Dintel Minimo

170 Hoja Sección tubular 60x30mm  
 230 Hoja Sección tubular 80x40mm  
 270 Hoja Sección tubular 100x40mm

Para puertas de 1 contrapeso y guía por detras del hueco:

- > Polea recta.
- > Dintel minimo.
  - Puerta 60x30 -> 120mm
  - Puerta 80x40 -> 160mm
  - Puerta 100x40 -> 160mm
  - Puerta de superficie > 30m2 -> 200mm

Detalle A

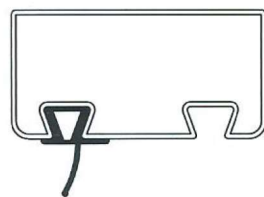

Detalle B

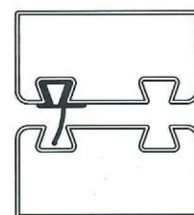

# APERTURA INTERIOR

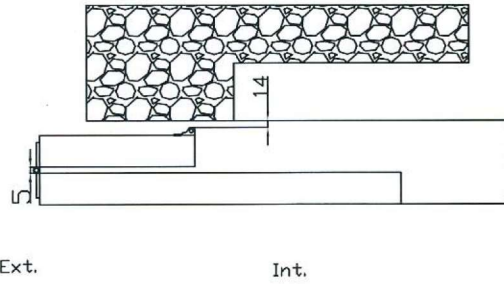
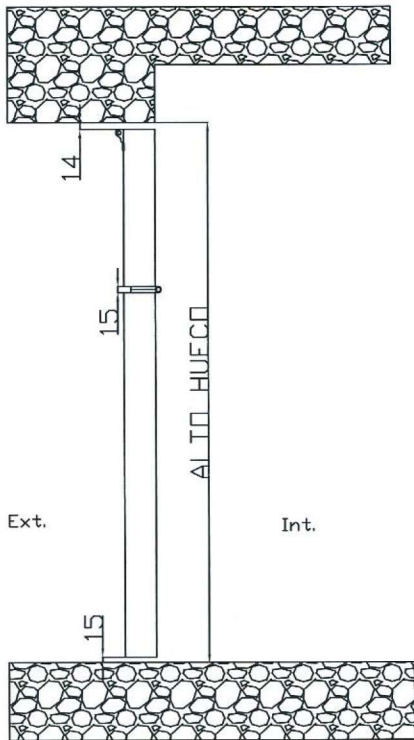

180 Hoja Sección tubular 60x30mm  
 230 Hoja Sección tubular 80x40mm  
 270 Hoja Sección tubular 100x40mm

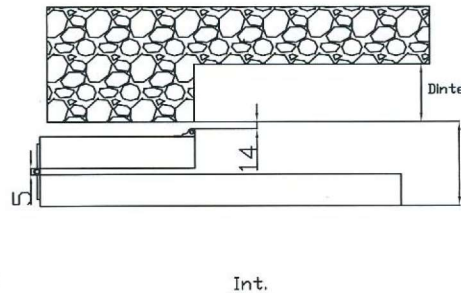
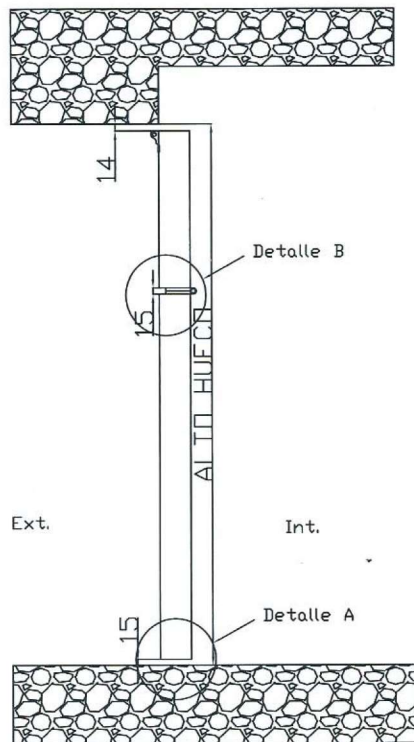

180 Hoja Sección tubular 60x30mm  
 230 Hoja Sección tubular 80x40mm  
 270 Hoja Sección tubular 100x40mm

Para puertas de 1 contrapeso y guía por detras del hueco:

- > Polea recta.
- > Dintel minimo.
  - Puerta 60x30 -> 120mm
  - Puerta 80x40 -> 160mm
  - Puerta 100x40 -> 160mm
  - Puerta de superficie > 30m2 -> 200mm

Detalle A

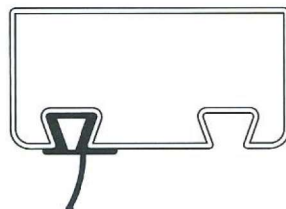

Detalle B

