

# Características Foxeo

# Características generales/dimensiones

	<b>Foxeo S</b>	<b>Foxeo HiS</b>
<b>Paso libre anchura (mm)</b>	<b>600 a 1000</b>	<b>600 a 1000</b>
<b>Paso libre altura (mm)</b>	<b>1875 a 2300</b>	<b>1875 a 2300</b>
<b>Espesor hoja (mm) *</b>	<b>66</b>	<b>66</b>
<b>Número de hojas</b>	<b>1</b>	<b>1</b>
<b>Número de bisagras</b>	<b>3</b>	<b>3</b>
<b>Número antipalanca</b>	<b>3</b>	<b>5</b>

# 3 tipos de cerco

- Rehabilitación

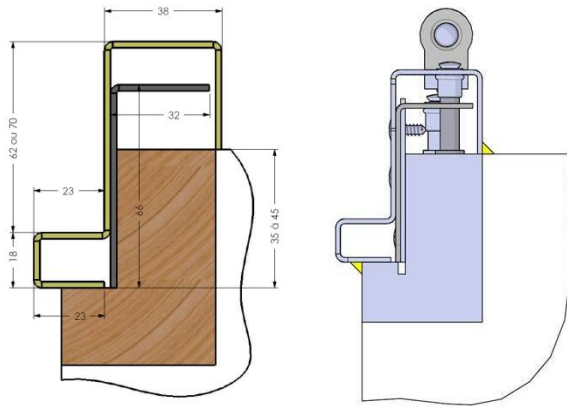

- Rehabilitación tubular

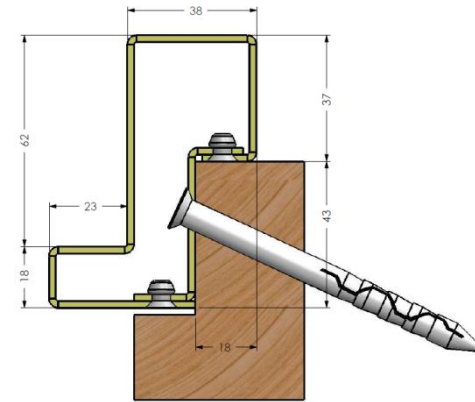

- Tubular / obra

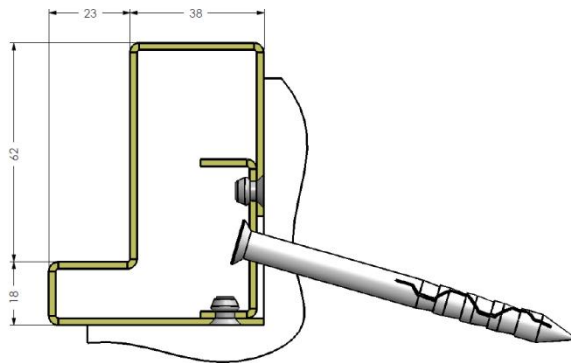

**Cerco de un solo color**

# Descriptivo hoja ( Foxeo HiS)

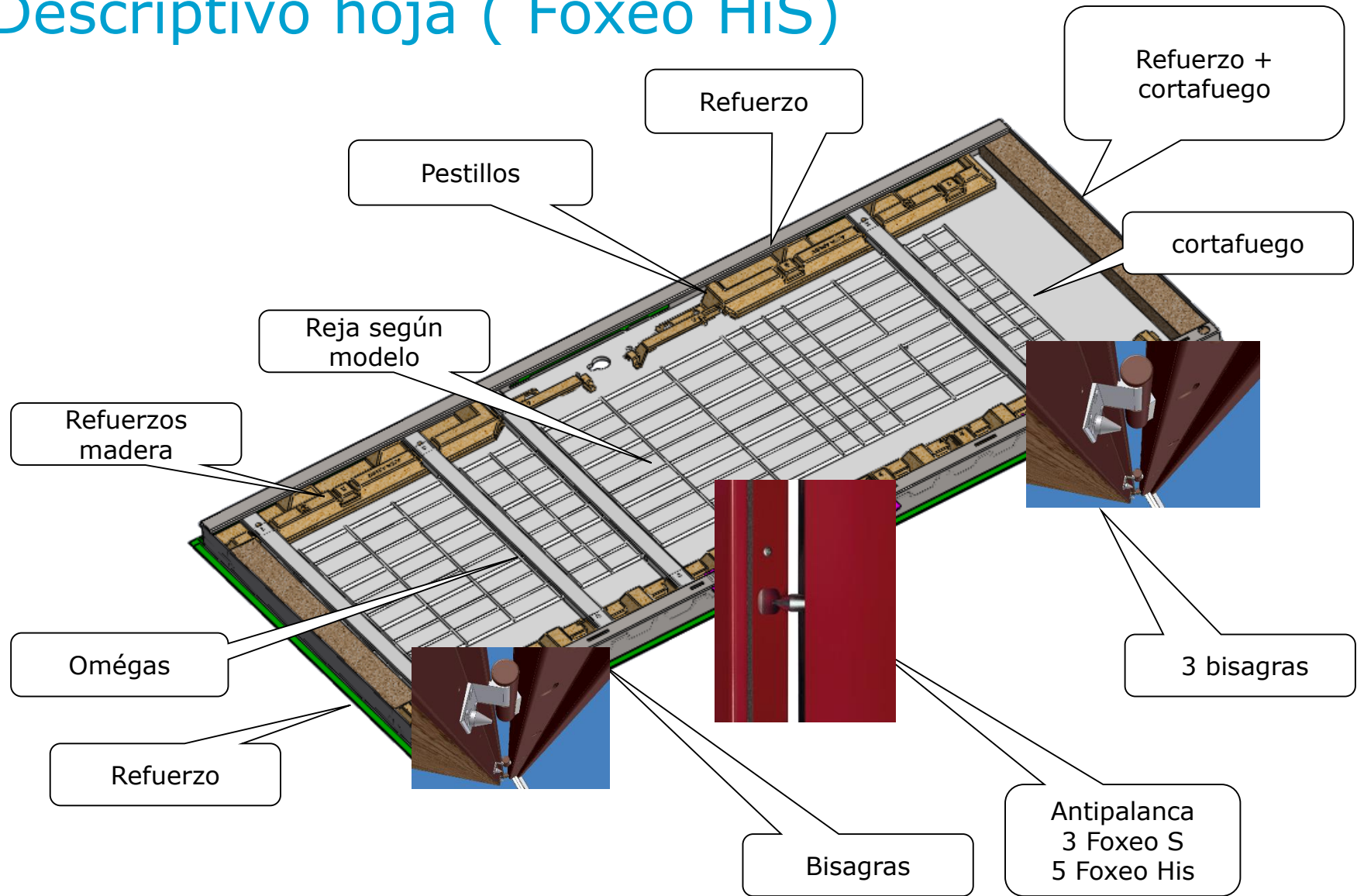

# La cerradura de Foxeo



	Foxeo S	Foxeo HiS
Tipo cerradura	encastrada de 40 mm	
caja central	cerradura T	cerradura T
cilindro control	No disponible	En opción
Cilindro	787 Z	787 Z F3D en opción
Puntos de cierre	2 pestillos gancho + 1 doble pestillo central	4 pestillos gancho + 1 doble pestillo central



# Umbral: barra de umbral o paravientos

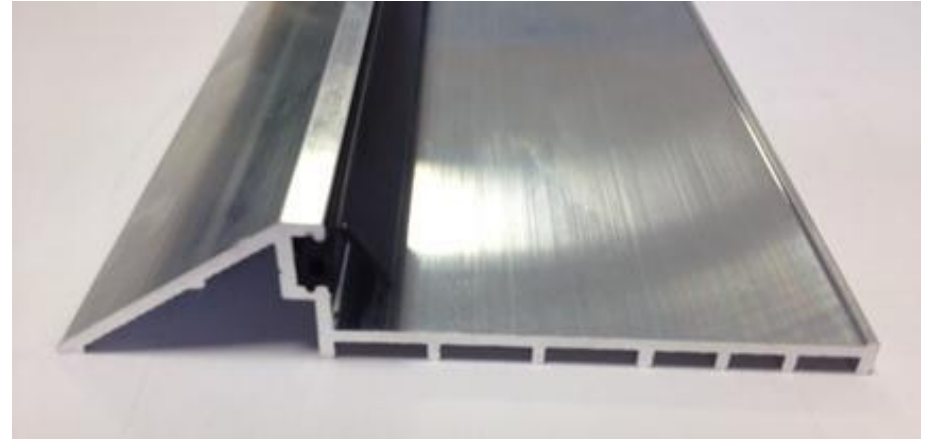

# Los equipamientos

- Los mismos equipamientos que Spheris
- **Elección**  
interior/exterior
- Mirilla bicolor según acabados equipamientos



# Equipamientos: cromado cepillado o laton

- **Manilla / Manilla**



- **Manilla / Aleron/boton**







- **Cono**





# Anti-efracción Foxeo



	Foxeo S	Foxeo HiS
<b>A2P</b>	 <b>BP1</b>	 <b>BP2</b>
<b>A2P</b>	 <b>1*</b>	 <b>3*</b>

# Resistencia al fuego Foxeo



	<b>Foxeo S</b>	<b>Foxeo HiS</b>
<b>Resistencia al fuego</b>	<b>EI230 cerco rehabilitación</b>	<b>EI230 cerco rehabilitación</b>

# Aislamiento acustico Foxeo



	<b>Foxeo S</b>	<b>Foxeo HiS</b>
<b>Aislamiento acustico</b>	<b>Rw(C ;Ctr) 36 (-1 ; -3) dB</b>	<b>Rw(C ;Ctr) 36 (-1 ; -3) dB</b>

# Aislamiento térmico Foxeo

	<b>Foxeo S</b>	<b>Foxeo HiS</b>
<b>de serie</b>	<b>2.2 W/m<sup>2</sup>.°K</b>	<b>2.2 W/m<sup>2</sup>.°K</b>

# Foxeo S y HiS : Decoracion hoja tonos RAL

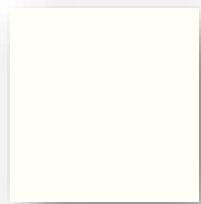

**Blanco  
9010**

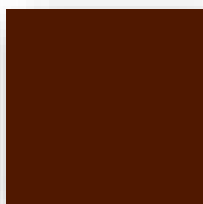

**Marron  
8014**

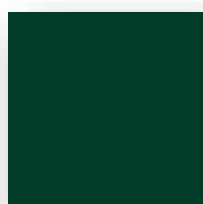

**Verde  
6005**

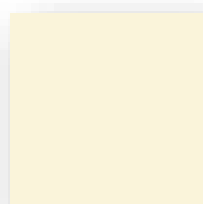

**Marfil  
1015**



**Azul  
5008**

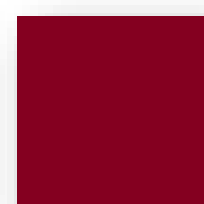

**Rojo  
3004**

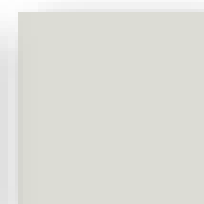

**Gris  
7035**

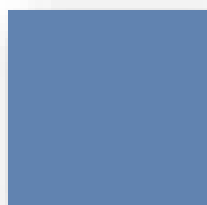

**Azul  
claro  
5014**

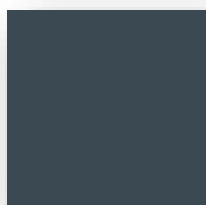

**Gris  
7015**

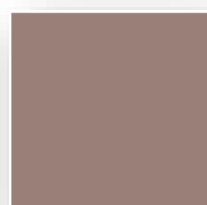

**Gris  
7030**

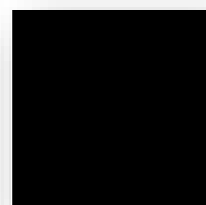

**Negro90  
05**

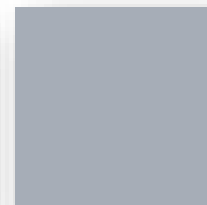

**Aluminio  
9006**

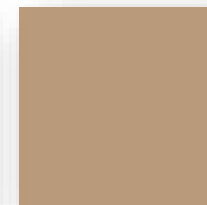

**Beige  
1019**

**Exterior: todos los tonos**

**Interior: blanco 9010, marron 8014 y marfil 1015 de serie, resto colores en opción**

# Foxeo S y HiS : moldurados exterior

**Solo tonos RAL**



Mod. 1



Mod. 2



Mod. 3

# Foxeo S y HiS : simil madera



**caoba  
claro**



**Caoba  
oscuro**



**Roble  
claro**



**Roble  
oscuro**



**Teca**



**Wengué**



**Haya**

# Otras opciones

- Pomo central



- Mirilla



- Retenedor manual





# Resumen de las opciones

	<b>FOXEO S</b>	<b>FOXEO HiS</b>
<b>Retenedor manual</b>	<b>X</b>	<b>X</b>
<b>Mirilla</b>	<b>X</b>	<b>X</b>
<b>Mirilla digital</b>	<b>X</b>	<b>X</b>
<b>paravientos</b>	<b>X</b>	<b>X</b>
<b>Pomo central</b>	<b>X</b>	<b>X</b>
<b>Cilindro de control</b>	<b>no disponible</b>	<b>X</b>
<b>Cilindro F3D</b>	<b>no disponible</b>	<b>X</b>